

SeriesOne DR Series
ATEX



- Ratings 3 Amps
- Load voltage ratings of 1-60 VDC, 1-100 VDC, 24-280 VAC and 48-600 VAC
- Fits standard 35mm DIN Rail
- LED input status indicator
- AC or DC control
- Zero Voltage (resistive loads) or Instantaneous (inductive loads) turn-on output
- UL 508 Endurance Rating for Enhanced Reliability
- UL Class I and II, Division 2, for Hazardous Locations

PRODUCT SELECTION

| Control Voltage | 280V, 3 A | 600V, 3 A | 60V, 3 A | 100V, 3 A |
|-----------------|-----------|-----------|----------|-----------|
| 4-32 VDC | DR24D03X | DR48D03X | DR06D03X | DR10D03X |
| 90-140 VAC | DR24B03X | | | |
| 200-280 VAC | DR24A03X | | | |
| 18-36 VAC | DR24E03X | | | |

AVAILABLE OPTIONS

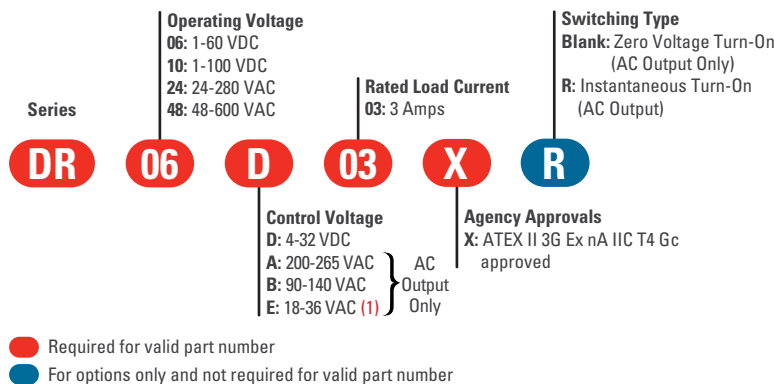

OUTPUT SPECIFICATIONS AC Output ⁽²⁾

| Description | DR24x03X | DR48x03X | DR06D03X | DR10D03X |
|--|----------------|----------------|----------------|----------------|
| Operating Voltage ⁽³⁾ | 24-280 Vrms | 48-600 Vrms | 1-60 VDC | 1-100 VDC |
| Transient Overvoltage [Vpk] | 600 | 1200 | N/A | N/A |
| Maximum Load Current, resistive ⁽⁴⁾ | 3 Arms | 3 Arms | 3 | 3 |
| Minimum Load Current | 150 mArms | 150 mArms | 2.5 mAdc | 2.5 mAdc |
| Maximum Off-State Leakage Current @ Rated Voltage [mA] | 0.1 | 0.1 | 0.1 | 0.1 |
| Minimum Off-State dv/dt @ Maximum Rated Voltage [V/µsec] ⁽⁵⁾ | 500 | 500 | N/A | N/A |
| Maximum On-State Voltage Drop @ Rated Current [Vpk] | 1.3 | 1.3 | 0.6 | 0.6 |
| Maximum Surge Current (50/60Hz, 1 cycle) [Apk] | 285/300 | 285/300 | 60 | 60 |
| Maximum I ² t for Fusing (50/60 Hz, 1/2 cycle) [A ² sec] | 410/375 | 410/375 | N/A | N/A |
| HP Rating UL 508/IEC60947 [HP (KW)] @ 240V | 1/4 (.18) | 1/4 (.18) | N/A | N/A |
| HP Rating UL 508/IEC60947 [HP (KW)] @ 380V | N/A | 1/3 (.25) | N/A | N/A |
| HP Rating UL 508/IEC60947 [HP (KW)] @ 480V | N/A | 1/2 (.37) | N/A | N/A |
| Minimum Power Factor (at Maximum Load) | 0.5 | 0.5 | N/A | N/A |
| Min/Max stranded wire | 22/14 AWG | 22/14 AWG | 22/14 AWG | 22/14 AWG |
| Min/Max solid wire | 22/14 AWG | 22/14 AWG | 22/14 AWG | 22/14 AWG |
| Weight (Typical) | 1.76 oz. (50g) | 1.76 oz. (50g) | 1.76 oz. (50g) | 1.76 oz. (50g) |

INPUT SPECIFICATIONS (2)

| Description | DRxxDxxX | DRxxBxxX | DRxxAxxX | DRxxExxX |
|-------------------------------------|-----------|-------------|--------------|----------------|
| Control Voltage Range (6) | 4-32 VDC | 90-140 Vrms | 200-265 Vrms | 18-36 Vrms (1) |
| Minimum Turn-On Voltage | 4.0 VDC | 90 Vrms | 200 Vrms | 18 Vrms |
| Must Turn-Off Voltage | 1.0 VDC | 10 Vrms | 40 Vrms | 4 Vrms |
| Minimum Input Current for [mA] (7) | 9 | 3 | 2.5 | 3.5 |
| Maximum Input Current for [mA] (7) | 11 | 5 | 3.3 | 8 |
| Maximum Turn-on Time [msec] (8) (9) | 1/2 Cycle | 20 msec | 20 msec | 20 msec |
| Maximum Turn-off Time [msec] (10) | 1/2 Cycle | 30 msec | 30 msec | 30 msec |
| Min/Max stranded/solid wire | 22/16 AWG | 22/16 AWG | 22/16 AWG | 22/16 AWG |

GENERAL SPECIFICATIONS (1)

| Description | Parameters |
|--|---------------------------|
| Dielectric Strength, Input/Output/Base (50/60Hz) | 4000 Vrms (11) |
| Minimum Insulation Resistance (@ 500 VDC) | 10 ⁹ Ohm |
| Maximum Capacitance, Input/Output | 10 pF |
| Ambient Operating Temperature Range | -20 to 40 °C |
| Ambient Storage Temperature Range | -30 to 100 °C |
| Recommended Terminal Screw Torque Range | 4.4-7.0 in-lb (0.5-0.8Nm) |

GENERAL NOTES

- (1) E option is UL certified for AC control voltage, but it works also with 18-36 VDC input range.
- (2) All parameters at 25°C unless otherwise specified.
- (3) For AC output frequency is 47-63Hz
- (4) See Derating curves
- (5) Off-State dv/dt test method per EIA/NARM standard RS-443, paragraph 13.11.1
- (6) DC control includes reverse polarity protection.
- (7) Input circuitry incorporates active current limiter.
- (8) Turn-on time for DC control random turn-on versions is 0.1 msec.
- (9) Turn-on time for DC output 600µsec.
- (10) Turn-off time for DC output 300µsec.
- (11) 2500 Vrms for DC output.

Standards of Compliance

IEC 62314

LC A, Resistive or Slightly Inductive Load Ratings: 3 A @40°C ambient for DR24x03X, 3 A @ 40°C ambient for DR48x03X

LC B, Motor Loads Ratings: 0.18KW @ 240VAC for DR24x03X and 0.375KW @ 480 VAC DR48x13X

Shock and Vibration (Applies to all part numbers)

Vibration Resistance according to IEC 60068-2-6: **0.35mm and 0.75mm Amplitude over 10-55 Hz**

Shock Resistance according to IEC 60068-2-27: **15g/11ms**

EMC (Applies to all part numbers)

IEC 61000-4-2: Electrostatic Discharge- Level 3

IEC 61000-4-4: Electrically Fast Transients- Level 3

IEC 61000-4-5: Electrical Surges- Level 3

ANSI / ISA 12.12.01-2013

Nonincendive Electrical Equipment for Use in Class I and II, Division 2 and Class III, Division 1 and 2 Hazardous (classified) locations

This equipment is open-type device and is meant to be installed in an enclosure suitable for the environment such that the equipment is only accessible with the use of a tool suitable for use in Class 1, Division 2, Group A,B,C and Hazardous locations, or Nonhazardous locations only

WARNING-Explosion Hazard- Do not disconnect equipment while the circuit is live or unless the area is known to be free of ignitable concentrations

WARNING-Explosion Hazard- Substitution of any component may impair suitability for class I, Division 2

ATEX

Compliance with Essential Health and Safety Requirements has been assessed by reference to Standards EN 60079-0:2012+A11:2013 and EN 60079-15:-2010

MECHANICAL SPECIFICATIONS (2)

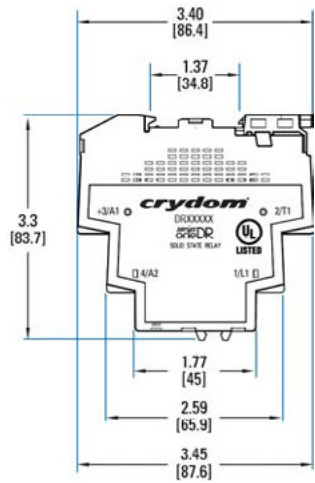
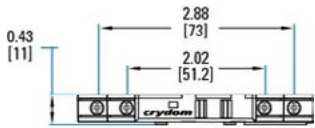

EQUIVALENT CIRCUIT BLOCK DIAGRAMS/WIRING DIAGRAMS

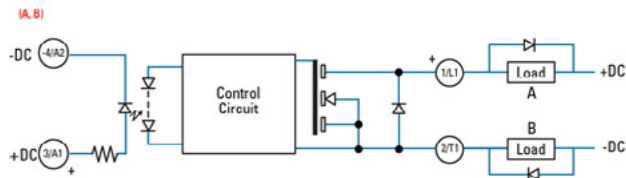
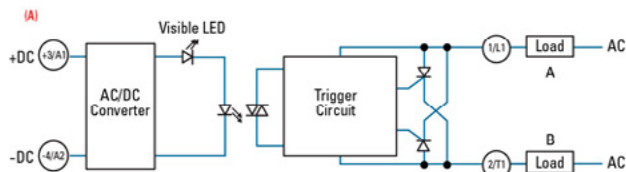
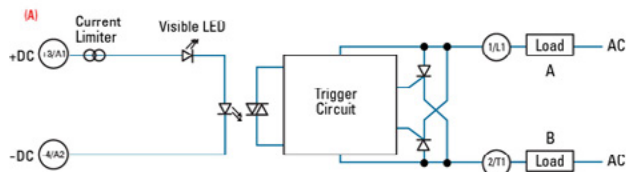

(A) Load can be wired in position A or B
 (B) Inductive loads must be diode suppressed to prevent damage to SSR

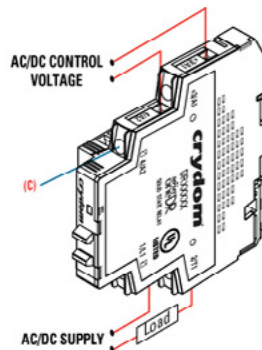

(C) 4 Terminal screws Pozidrive #1, 3/16 in (4.8 mm). Minimum wire insulation strip length 0.20 in (5.1 mm), maximum 0.28 in (7.1 mm).

THERMAL DERATE INFORMATION

Derating Curves are not approved for the ATEX Certification

DRxxx03X

----- Single and multiple units

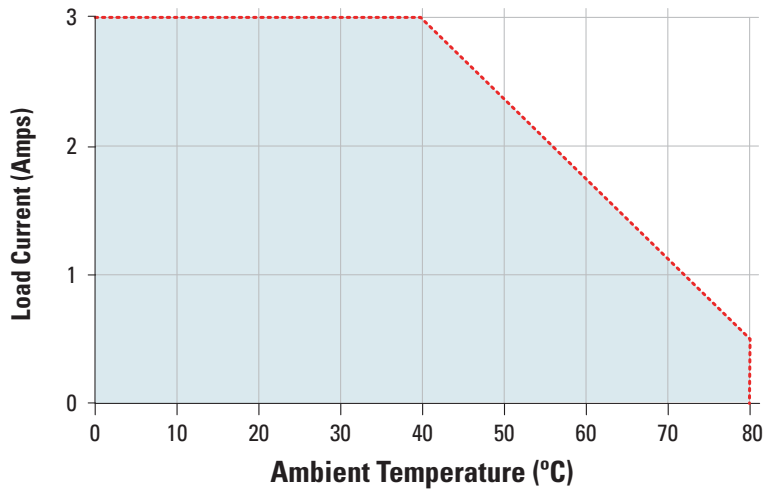

AGENCY APPROVALS

Agency Approvals



Rev 052516

ACCESSORIES**ID Marker Strips**
CNLB, CNLN, CNL2**Blank Strips**

Part no.: CNLB

A package of 10 plastic strips comprising 10 individual unprinted markers which can be placed on sockets' terminal block for easy identification during the use of multiple units.

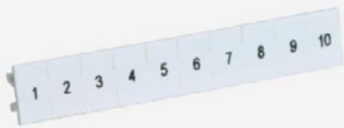
**Numbered 1 to 10 Strips**

Part no.: CNLN

A package of 10 plastic strips comprising 10 markers printed individually from 1 to 10 which can be placed on sockets' terminal block for easy identification during the use of multiple units.

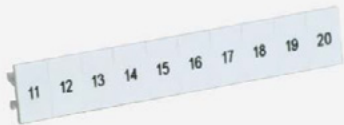
**Numbered 11 to 20 Strips**

Part no.: CNL2

A package of 10 plastic strips comprising 10 markers printed individually from 11 to 20 which can be placed on sockets' terminal block for easy identification during the use of multiple units.

⚠ DANGER / PELIGRO / DANGER /GEFAHR / PERICOLO / 危險

| | | | | | |
|--|--|---|--|--|---|
| <p>HAZARD OF ELECTRIC SHOCK, EXPLOSION, OR ARC FLASH.</p> <ul style="list-style-type: none"> • Disconnect all power before installing or working with this equipment. • Verify all connections and replace all covers before turning on power. <p>Failure to follow these instructions will result in death or serious injury.</p> | <p>RIESGO DE DESCARGA ELECTRICA O EXPLOSION.</p> <ul style="list-style-type: none"> • Desconectar todos los suministros de energia a este equipo antes de trabajar con este equipo. • Verificar todas las conexiones y colocar todas las tapas antes de energizar el equipo. <p>El incumplimiento de estas instrucciones puede provocar la muerte o lesiones serias.</p> | <p>RISQUE DE DESCARGE ELECTRIQUE OU EXPLOSION</p> <ul style="list-style-type: none"> • Eteindre toutes les sources d'énergie de cet appareil avant de travailler dessus de cet appareil • Vérifier tous connections, et remettre tous couverts en olace avant de mettre sous <p>De non-suivi de ces instructions provoquera la mort ou des lésions sérieuses.</p> | <p>GEFAHR EINES ELEKTRISCHE N SCHLAGES ODER EINER EXPLOSION.</p> <ul style="list-style-type: none"> • Stellen Sie jeglichen Strom ab, der dieses Gerät versorgt, bevor Sie an dem Gerät Arbeiten durchführen • Vor dem Drehen auf Energie alle Anschlüsse überprüfen und alle Abdeckungen ersetzen. <p>Unterlassung dieser Anweisungen können zum Tode oder zu schweren Verletzungen führen.</p> | <p>RISCHIO DI SCOSSA ELETTRICA O DELL'ESPLOSIONE.</p> <ul style="list-style-type: none"> • Spenga tutta l'alimentazione che fornisce questa apparecchiatura prima di lavorare a questa apparecchiatura • Verificare tutti i collegamenti e sostituire tutte le coperture prima dell'accensione <p>L'omissione di queste istruzioni provocherà la morte o lesioni serie</p> | <p>存在电击、爆炸或电弧闪烁危险</p> <ul style="list-style-type: none"> • 在操作此设备之前请先关闭电源。 <p>若不遵守这些说明,可能会导致严重的人身伤害甚至死亡。</p> |
|--|--|---|--|--|---|

⚠ WARNING / AVERTISSEMENT / WARNUNG /ADVERTENCIA / AVVERTENZA / 警告

| | | |
|--|--|--|
| <p>RISK OF MATERIAL DAMAGE AND HOT ENCLOSURE</p> <ul style="list-style-type: none"> • The product's side panels may be hot, allow the product to cool before touching. • Follow proper mounting instructions including torque values. • Do not allow liquids or foreign objects to enter this product. <p>Failure to follow these instructions can result in serious injury, or equipment damage.</p> | <p>RISQUE DE DOMMAGE MATERIEL ET DE SURCHAUFFE DU BOITIER</p> <ul style="list-style-type: none"> • Les panneaux latéraux du produit peuvent être chauds. Laisser le produit refroidir avant de le toucher. • Respecter les consignes de montage, et notamment les couples de serrage. • Ne pas laisser pénétrer de liquide ni de corps étrangers à l'intérieur du produit. <p>Le non-respect de cette directive peut entraîner, des lésions corporelles graves ou des dommages matériels.</p> | <p>GEFAHR VON MATERIALSCHÄDEN UND GEHÄUSEERHITZUNG</p> <ul style="list-style-type: none"> • Die Seitenwände können heiß sein. Lassen Sie das Produkt abkühlen, bevor Sie es berühren. • Beachten Sie die Montageanweisungen, • Führen Sie keine Flüssigkeiten oder Fremdkörper in das Produkt ein. <p>Die Nichtbeachtung dieser Anweisung kann Körperverletzung oder Materialschäden zur Folge haben.</p> |
| <p>RIESGO DE DAÑOS MATERIALES Y DE SOBRECALENTAMIENTO DE LA UNIDAD</p> <ul style="list-style-type: none"> • Los paneles laterales del producto pueden estar calientes. Esperar que el producto se enfríe antes de tocarlo. • Respetar las instrucciones de montaje, y en particular los pares de apretado. • No dejar que penetren líquidos o cuerpos extraños en el producto. <p>Si no se respetan estas precauciones pueden producirse graves lesiones, daños materiales.</p> | <p>RISCHIO DI DANNI MATERIALI E D'INVOLUCRO CALDO</p> <ul style="list-style-type: none"> • I pannelli laterali dell'apparecchio possono scottare; lasciar quindi raffreddare il prodotto prima di toccarlo. • Seguire le istruzioni di montaggio corrette. • Non far entrare liquidi o oggetti estranei in questo apparecchio. <p>La mancata osservanza di questa precauzione può causare gravi rischi per l'incolumità personale o danni alle apparecchiature.</p> | <p>材料损坏和高温外壳的危险性</p> <ul style="list-style-type: none"> • 产品的一侧面板可能很热, 在其冷却前请不要触碰。 • 遵照正确的安装说明, 包括扭矩值。 • 请勿让液体及其他异物进入本产品。 <p>如不能正确执行这些操作说明, 极有可能造成严重人体伤害或者设备的损坏。</p> |

ANNEX - ENVIROMENTAL INFORMATION

The environmental information disclosed in this annex including the EIP Pollution logo are in compliance with People’s Republic of China Electronic Industry Standard SJ/T11364 – 2006, Marking for Control of Pollution Caused by Electronic Information Products.

| Part Name | Toxic or hazardous Substance and Elements | | | | | |
|-------------------|---|--------------|--------------|-------------------------------|--------------------------------|---------------------------------------|
| | Lead (Pb) | Mercury (Hg) | Cadmium (Cd) | Hexavalent Chromium (Cr (VI)) | Polybrominated biphenyls (PBB) | Polybrominated diphenyl ethers (PBDE) |
| Semiconductor die | X | ○ | ○ | ○ | ○ | ○ |
| Solder | X | ○ | ○ | ○ | ○ | ○ |

附件 - 环保信息

此附件所标示的包括电子信息产品污染图标的环保信息符合中华人民共和国电子行业标准 SJ/T11364 - 2006, 电子信息产品污染控制标识要求。

| 部件名称 | 有毒有害物质或元素 | | | | | |
|-------|-----------|--------|--------|---------------|------------|--------------|
| | 铅 (Pb) | 汞 (Hg) | 镉 (Cd) | 六价铬 (Cr (VI)) | 多溴联苯 (PBB) | 多溴二苯醚 (PBDE) |
| 半导体芯片 | X | ○ | ○ | ○ | ○ | ○ |
| 焊接点 | X | ○ | ○ | ○ | ○ | ○ |



Datasheets provided by Sensata Technologies, Inc., its subsidiaries and/or affiliates (“Sensata”) are solely intended to assist third parties (“Buyers”) who are developing systems that incorporate Sensata products (also referred to herein as “components”). Buyer understands and agrees that Buyer remains responsible for using its independent analysis, valuation, and judgment in designing Buyer’s systems and products. Sensata datasheets have been created using standard laboratory conditions and engineering practices. Sensata has not conducted any testing other than that specifically described in the published documentation for a particular datasheet. Sensata may make corrections, enhancements, improvements, and other changes to its datasheets or components without notice.

Buyers are authorized to use Sensata datasheets with the Sensata component(s) identified in each particular datasheet. HOWEVER, NO OTHER LICENSE, EXPRESS OR IMPLIED, BY ESTOPPEL OR OTHERWISE TO ANY OTHER SENSATA INTELLECTUAL PROPERTY RIGHT, AND NO LICENSE TO ANY THIRD PARTY TECHNOLOGY OR INTELLECTUAL PROPERTY RIGHT, IS GRANTED HEREIN. SENSATA DATASHEETS ARE PROVIDED “AS IS”. SENSATA MAKES NO WARRANTIES OR REPRESENTATIONS WITH REGARD TO THE DATASHEETS OR USE OF THE DATASHEETS, EXPRESS, IMPLIED, OR STATUTORY, INCLUDING ACCURACY OR COMPLETENESS. SENSATA DISCLAIMS ANY WARRANTY OF TITLE AND ANY IMPLIED WARRANTIES OF MERCHANTABILITY, FITNESS FOR A PARTICULAR PURPOSE, QUIET ENJOYMENT, QUIET POSSESSION, AND NON-INFRINGEMENT OF ANY THIRD PARTY INTELLECTUAL PROPERTY RIGHTS WITH REGARD TO SENSATA DATASHEETS OR USE THEREOF.

All products are sold subject to Sensata’s terms and conditions of sale supplied at www.sensata.com. SENSATA ASSUMES NO LIABILITY FOR APPLICATIONS ASSISTANCE OR THE DESIGN OF BUYERS’ PRODUCTS. BUYER ACKNOWLEDGES AND AGREES THAT IT IS SOLELY RESPONSIBLE FOR COMPLIANCE WITH ALL LEGAL, REGULATORY, AND SAFETY-RELATED REQUIREMENTS CONCERNING ITS PRODUCTS, AND ANY USE OF SENSATA COMPONENTS IN ITS APPLICATIONS, NOTWITHSTANDING ANY APPLICATIONS-RELATED INFORMATION OR SUPPORT THAT MAY BE PROVIDED BY SENSATA.

Mailing Address: Sensata Technologies, Inc., 529 Pleasant Street, Attleboro, MA 02703, USA

CONTACT US

Regional head offices:

United States of America

Sensata Technologies

Attleboro, MA

Phone: 508-236-3800

E-mail: support@sensata.com

Netherlands

Sensata Technologies Holland B.V.

Hengelo

Phone: +31 74 357 8000

E-mail: support@sensata.com

China

Sensata Technologies China Co., Ltd.

Shanghai

Phone: +8621 2306 1500

E-mail: support@sensata.com

Copyright © 2023 Sensata Technologies, Inc.