











# NMS300 Series Digital Readout



## USER MANUAL

# Contents

<b>Specification</b>	Page 3	
Electrical	Page 3	
Physical	Page 3	
Environment	Page 3	
Accreditation	Page 3	
Disposal	Page 3	
Input and Resolution	Page 3	
<b>Mounting Options</b>	Page 4	
Mill Mount	Page 4	
Lathe Mount	Page 4	
<b>Connection Details</b>	Page 5	
Important Information	Page 5	
Connections	Page 5	
<b>Display and Keypad</b>	Page 6	
Understanding the Display	Page 6	
Understanding the Keypad	Page 6	
<b>Setting up the Unit</b>	Page 7	
Navigating Complete Setup	Page 7	
Navigating Complete Setup (Continued)	Page 8	
Language Setup	Page 9	
Type Setup	Page 9	
Encoder Resolution Setup	Page 9	
Direction of Travel Setup	Page 10	
Radius / Diameter (Measure Setup)	Page 10	
Error Compensation	Page 10/11	
Linear Error Compensation	Page 12	
Linear Error Compensation Setup	Page 13/14	
Segmented Error Compensation Setup	Page 15/16	
Using Segmented Error Compensation	Page 17	
Plane Setup	Page 18	
Functions Setup	Page 18	
Feed Setup	Page 19	
Brightness Setup	Page 19	
Beep Setup	Page 19	
Sleep Setup	Page 20	
Reset Setup	Page 20	
<b>Standard Functions</b>	Page 21	
Absolute / Incremental	Page 21	
Inch / mm	Page 22	
Zero and Preset an Axis	Page 22	
Undo Function	Page 23	
1/2 Function / Centre Find	Page 23	
Function menu / function keys	Page 24/25	
Reference	Page 25/26	
Sub Datum Memory	Page 26/27/28	
Feed Rate	Page 28	
<b>Mill Functions</b>	Page 29	
Pitch Circle Diameter (PCD) / Bolt Hole	Page 29	
Line Hole	Page 30	
Arc Contouring	Page 31	
Pocket / Island	Page 32	
<b>Lathe Functions</b>	Page 33	
Tool Offsets	Page 33/34	
Taper Turning	Page 35	
<b>Trouble Shooting</b>	Page 36	

# Specification

## Electrical

EU Directive 73/23/EEC (Low Voltage Directive)  
BS EN 55022:1998 Class B  
BS EN 55024:1998

Input to Power Supply Unit (Supplied)  
100-240V (47-63Hz)  
External switch-mode - Output voltage 15VDC  
Input Voltage to NMS300 15-24VDC  $\pm 10\%$   
Conforms to Low Voltage Directive

## Physical

Height 160mm (6.3")	Depth 38.2mm (1.5")	Mounting Bolt: M10
Width 270mm (10.63")	Weight 1.5kg (3.3lb)	

## Environment

Climatic Range	Storage Temperature	-20°C to 70°C
	Working Temperature	-10°C to 50°C
	Working Humidity	95% R.H. at 31°C

IP-Ingress Protection      IP40 Stand Alone

## Accreditation

CE

## Disposal

At the end of its life, please dispose of the NMS300 system in a safe manner applicable to electrical goods

Do not burn

The casework is suitable for recycling. Please consult local regulations on disposal of electrical equipment

## Input and Resolution

Only Spherosyn 300 or Microsyn 300 encoders can be used with the NMS300 DRO

## Resolutions

### Spherosyn 300

5 $\mu$ m (0.0002")  
10 $\mu$ m (0.0005")  
20 $\mu$ m (0.001")  
50 $\mu$ m (0.002")

### Microsyn 300

2 $\mu$ m (0.0001")  
5 $\mu$ m (0.0002")  
10 $\mu$ m (0.0005")  
20 $\mu$ m (0.001")  
50 $\mu$ m (0.002")

Newall Measurement Systems Limited reserves the right to make changes to this specification without notice

# Mounting options

## Standalone Mount Options

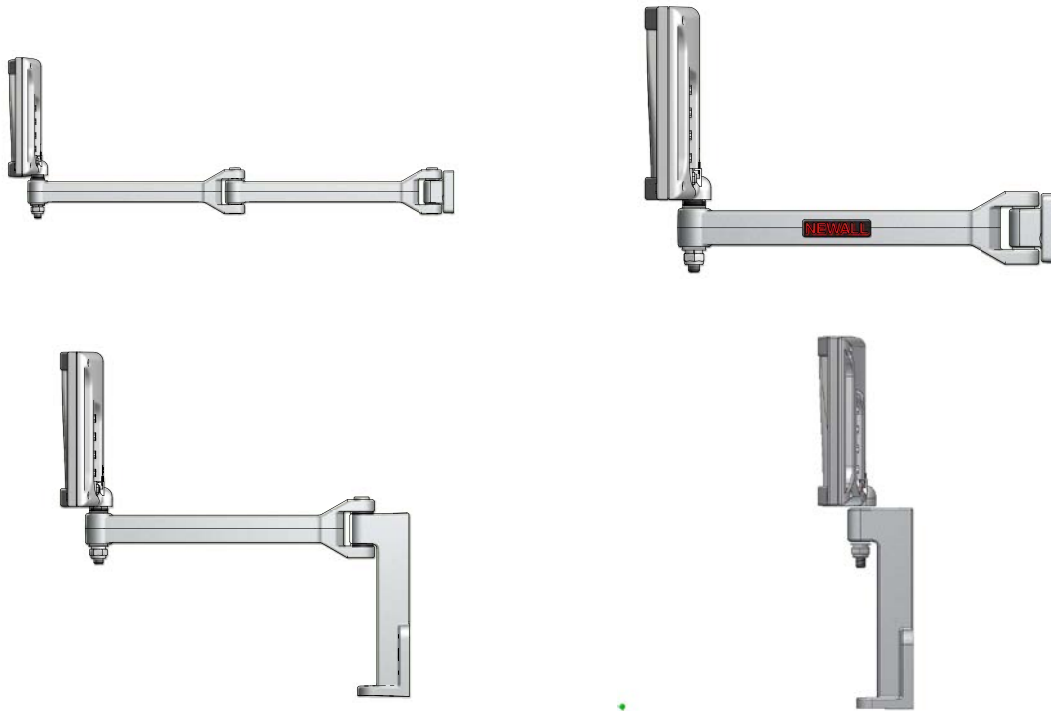

## Swivel Mount Option



## Panel Mount Option

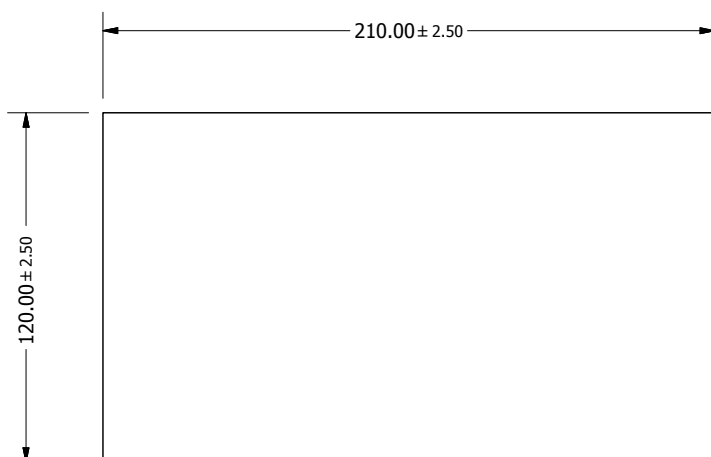

# Connection details

## Important Details

The NMS300 is only compatible with Newall Spherosyn 300 and Microsyn 300 encoders.

It is important to ensure that:

- ✓ Secure all the cables to prevent the connectors from dropping into hazardous positions (for example the floor or coolant tray) when they are unplugged.
- ✓ Route all cables to prevent them from being caught on moving parts.
- ✓ The NMS300 is grounded to the machine, using the braided grounding lead provided, before the machine supply is turned on.
- ✓ The power has been disconnected, before the encoder(s) are connected.

**Do not connect this unit directly to the mains supply.**

If an encoder connected to the NMS300 travels over 3.2m an error code (20000) will be displayed in the X axis and the other axes will go blank. See the trouble shooting guide for further details on page 34.

## Connections



# Display and keypad

## Understanding The Display



## Understanding The Keypad

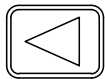

Axis selection key



Switches between zero and axis pre-set modes

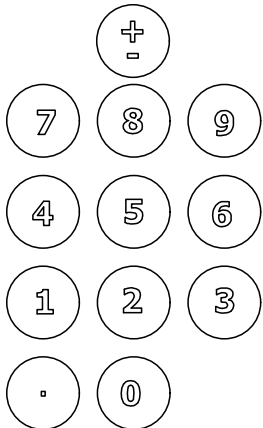

Numeric keys



Switches between absolute and incremental modes



Enter key



Switches between inch and mm display



Clear key



Back / undo key

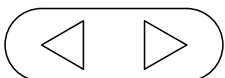

Navigation keys



Menu key



Calculator mode



Centre find

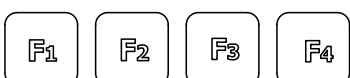

Function keys



Calculator functions

# Setting up the unit

## How to enter setup

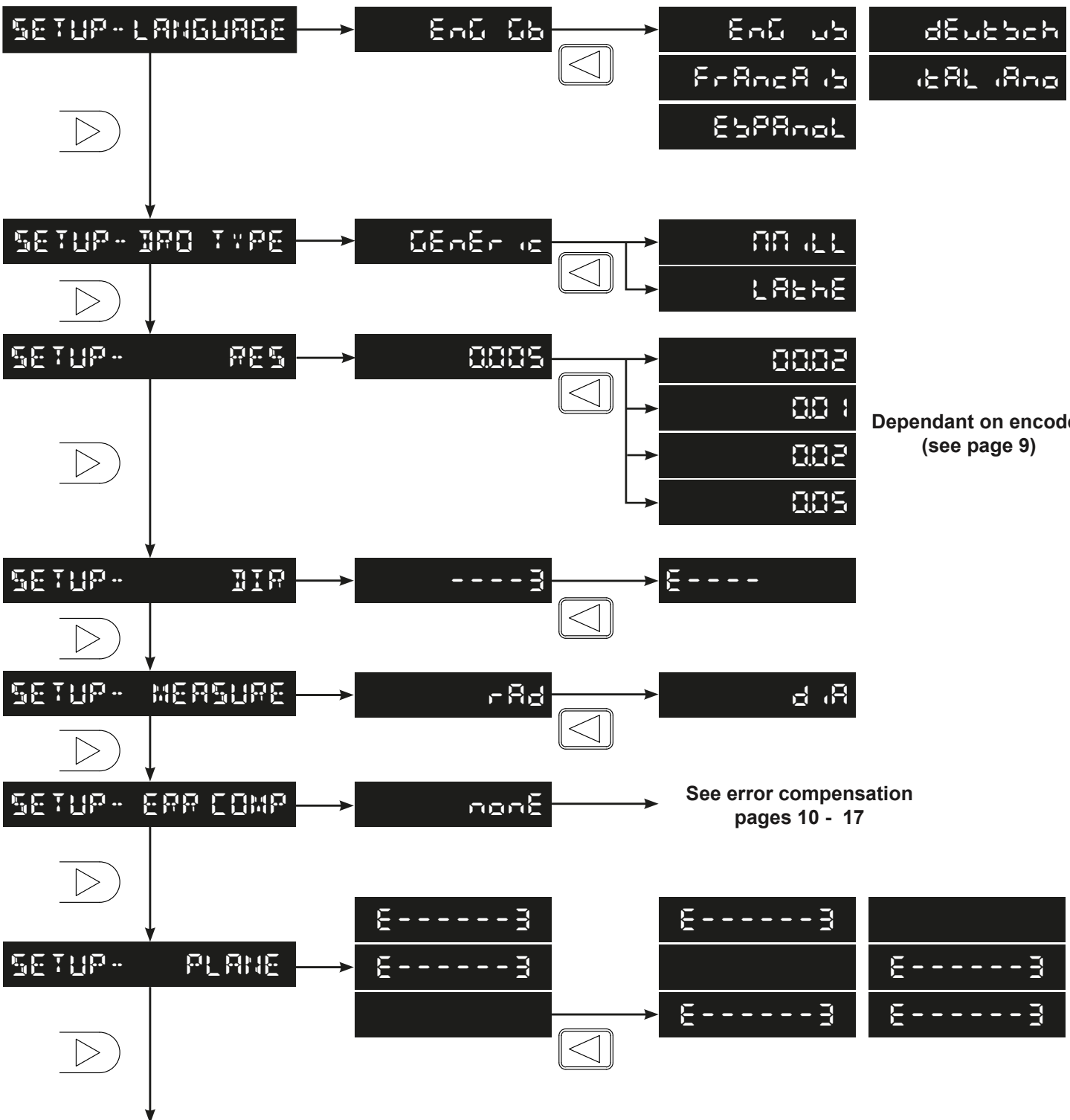
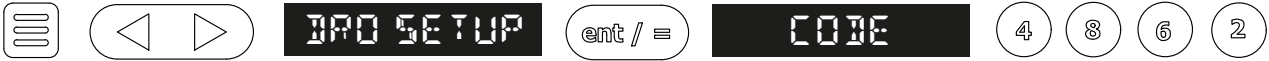

Dependant on encoder  
(see page 9)

See error compensation  
pages 10 - 17

# Setting up the unit

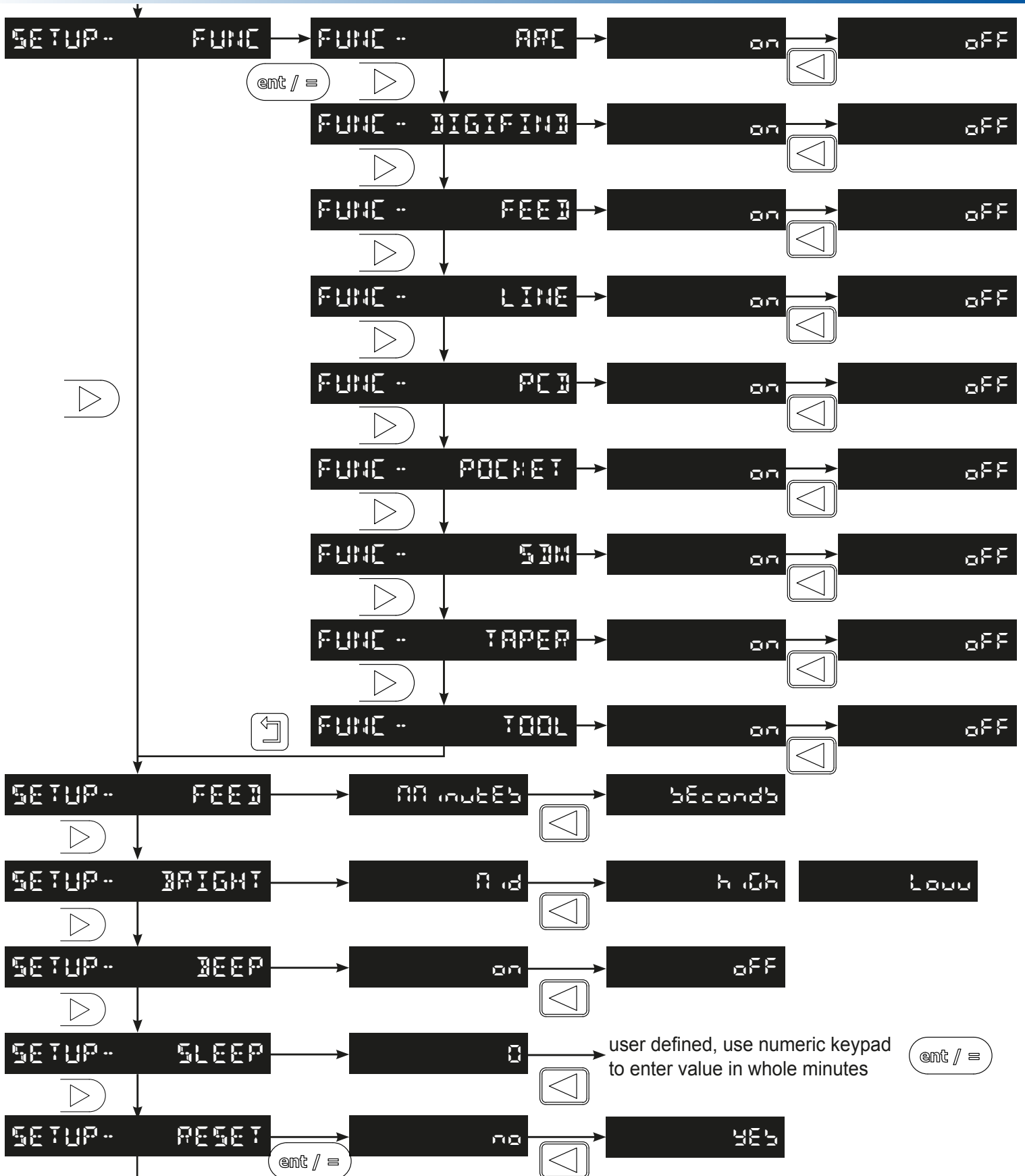



# Setting up the unit

## Language Setup

This setting enables the user to choose the language that is required to be displayed in the NMS300 display.

There are 6 language settings:

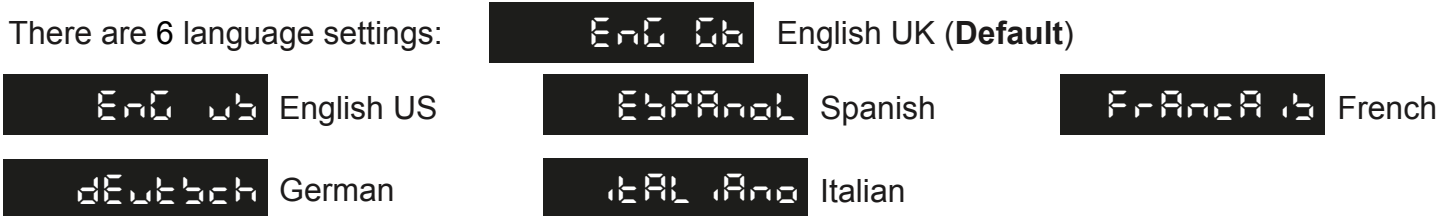

Press the axis select key  next to the 'X' axis to cycle through options

## Type Setup

This setting enables the user to choose the machine type that the NMS300 operates with. This is important as the machine type defines the default functions for the *functions keys* and *function menu*.

There are 3 settings to choose from:

<b>GENERIC</b>	<b>MILL</b>	<b>LATHE</b>
Generic (all functions)	Mill (mill functions)	Lathe (lathe functions, X axis set to DIA)
= Tool function	= PCD function	= Tool function
= PCD function	= Line function	= Taper function
= SDM function	= SDM function	= SDM function
= Digifind Function	= Digifind Function	= Digifind Function

**Note:** The function keys can be manually set to any function desired, see the *function keys* section

## Encoder Resolution Setup

The resolution settings available for each axis depend on the encoder type and the inch/mm setting

µm	Display		Spherosyn300	Microsyn300
	mm	in		
2	0.002	0.0001		✓
5	0.005	0.0002	✓	✓
10	0.01	0.0005	✓	✓
20	0.02	0.001	✓	✓
50	0.05	0.002	✓	✓

Press the axis select key  next to the 'X', 'Y' or 'Z' axis to cycle through the options

# Setting up the unit



## Direction of Travel Setup

This setting allows the user to match the NMS300 to the actual direction of travel of any of the 3 axes fitted to the machine.

The two settings available for each axis are  and 

Press the axis select key  next to the 'X', 'Y' or 'Z' axis to cycle through the options

### Example:

If the current setting is  and the travel is positive from right to left, changing the setting to  will reverse the direction to measure positive from left to right

## Radius / Diameter (measure setup)

The radius /diameter function allows the user to display actual (radius) or twice-actual (diameter) measurements for each axis.

This function is generally used in turning applications, such as the cross travel on a lathe where the diameter reading is displayed rather than the radius.

There are two setting for each axis:

Radius 

Diameter 

Press the axis select key  next to the 'X', 'Y' or 'Z' axis to cycle through the options

## Error Compensation

The digital readout (DRO) system helps to improve productivity. It decreases the number of scrapped parts, as there is no concern about making mistakes related to counting the revolutions on the dials. The DRO system also helps to eliminate some errors related to ball-screw backlash.

The DRO system will operate to its published accuracy, provided all components are in working order and properly installed. Field calibration is not necessary.

Accuracy problems with machined parts may be caused by machine error, DRO system error, or a combination of both. The first step in determining the source of error is to check the DRO system. To do this compare the movement of the Newall reader head to the position reading shown on the display. A high accuracy standard, such as a laser interferometer is required. A dial indicator can be used to check short distances, but a laser provides the best results. If a dial indicator must be used, be sure it is the highest available accuracy.

# Setting up the unit

## Error Compensation Continued

To check the accuracy of the DRO system:

1. Place the target of the laser or the needle of the dial indicator directly on the Newall reader head. It is absolutely critical that the readings are taken directly from the Newall reader head. If a dial indicator must be used, be sure that the needle of the indicator is perpendicular to the reader head and not angled. If readings are taken anywhere else on the machine, machine errors may distort the results.
2. When the reader head moves, the movement registers on the laser / indicator and DRO display.
3. Set the laser / dial indicator and DRO position displays to 0.
4. Make a series of movements and compare the position readings between the laser / dial indicator and the DRO display. If the readings match within the accuracy specified, it proves that the DRO system is operating properly. If this is the case, proceed to the next step: evaluating the machine errors. If the readings do not match, the DRO system must be repaired before proceeding with error compensation.

To evaluate machine errors:

1. Put the laser target / dial indicator on the part of the machine where the machining is done.
2. Make a series of movements and compare the position readings between the laser / dial indicator and the DRO display. The difference between the laser / dial indicator reading and the reading on the DRO display is the machine error.
3. Plot the machine error along the entire axis of travel to determine the nature of the error. If it is a linear error, use linear error compensation. If the error is not linear, use segmented error compensation.

## Types of Machine Error

There are many types of machine error, including pitch, roll, yaw, flatness, straightness, and Abbé error. The diagrams below demonstrate these errors.

Way errors

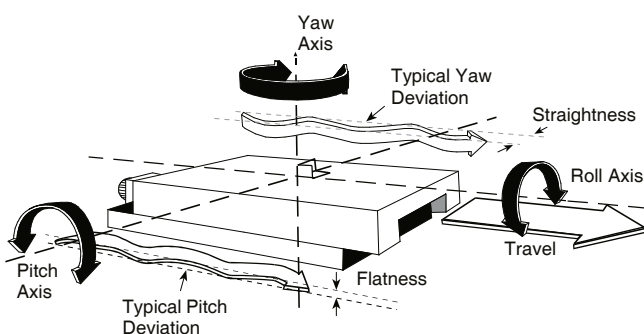

Abbé error

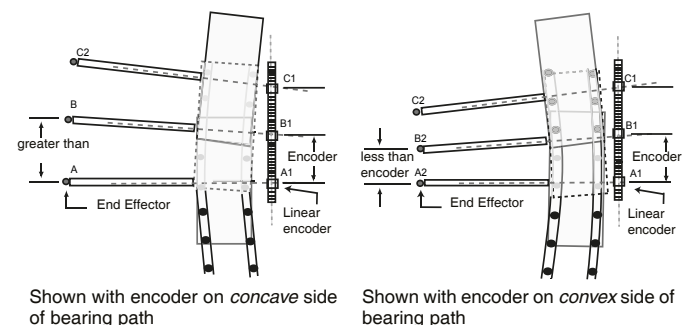

# Setting up the unit

## Linear Error Compensation

In this mode, a single constant correction factor is applied for each axis for all displayed measurements. Calculate the correction factor, and specify it in parts per million (ppm).

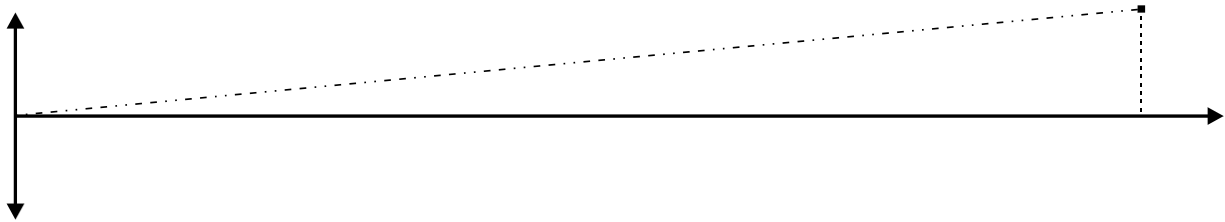

When following the procedure ensure that a stepped standard is used, and approach each edge from the same direction; or if each edge must be approached from opposite directions, then subtract the width of the tool or measuring probe from the value displayed on the NMS300.

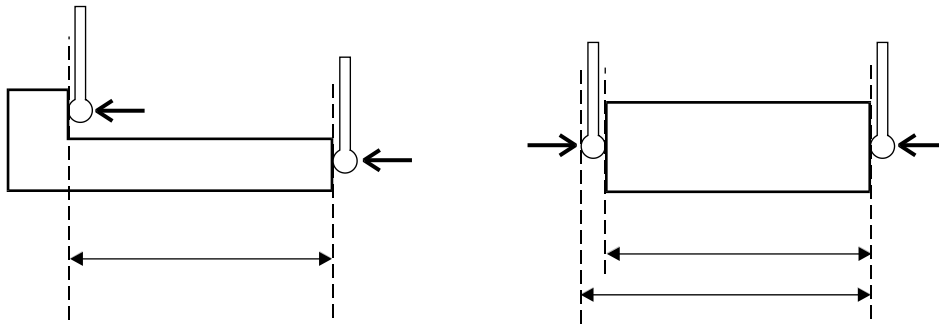

## Linear Error Compensation Setup

This setting allows the setup of compensation factors for linear errors. There are two methods of entering compensation values **Teach mode** and **Program mode**.

### Teach Mode



Teach mode is an easier way of calculating linear errors by using the NMS300 to automatically calculate the error. This is achieved by comparing the actual measurement and the physical movement.

The procedure to do this is shown below.

Navigate to the Error compensation selection screen `SETUP-- ERR COMP`

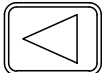
The default value for each of the axis is `NONE`

Press the axis select key  next to the 'X', 'Y' or 'Z' axis that requires linear compensation the message display will show `CMP 1-- NONE` (CMP 1 = X axis, CMP 2 = Y axis & CMP 3 = Z axis)

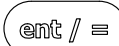
  until the message display shows `CMP 1-- LINEAR` 

# Setting up the unit

## Teach Mode Continued

0

last compensation value calculated / used

LIN 1- TEACH

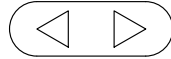

to choose teach rather than program

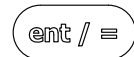

0000

encoder position (start point)

TCH 1- START



1000000

encoder position (end point)

TCH 1- END

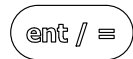

TCH 1- MOVEMENT

enter the actual measurement using the numeric keypad



1000500

value entered in previous step

TCH 1- MOVEMENT

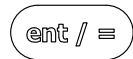

-500

Linear compensation value (ppm)

TCH 1- ACCEPT

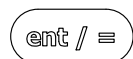

-500

LIN 1- TEACH



to exit setup and return to menu, or



to exit setup and return to measurement display

# Setting up the unit

## Program Mode

Program mode allows the linear compensation to be calculated manually and then entered as a PPM value into the NMS300 display.

The procedure to do this is shown below:

To illustrate the calculation an example is being used where the standard distance is 500.000mm and the measured distance is 500.200mm.

Correction factor = error / actual x 1,000,000



Correction factor = (500.000 - 500.200) / 500.000 x 1,000,000

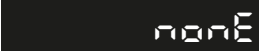

Correction factor = -400 PPM

To enter this value into the display:

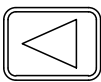
Navigate to the Error compensation selection screen 

The default value for each of the axis is 

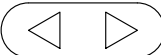
Press the axis select key  next to the 'X', 'Y' or 'Z' axis that requires linear compensation the message display will show  (CMP 1 = X axis, CMP 2 = Y axis & CMP 3 = Z axis)

 until the message display shows  

 last compensation value calculated / used

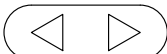
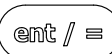
  to choose program rather than teach 

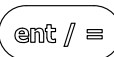
 enter the calculated PPM using the numeric keypad 





 to exit setup and return to menu, or  to exit setup and return to measurement display

# Setting up the unit

## Segmented Error Compensation

The scale travel is broken down into as many as 200 user-defined segments, each with their own correction factor, measured against a high-accuracy standard. The following parameters need to be identified:

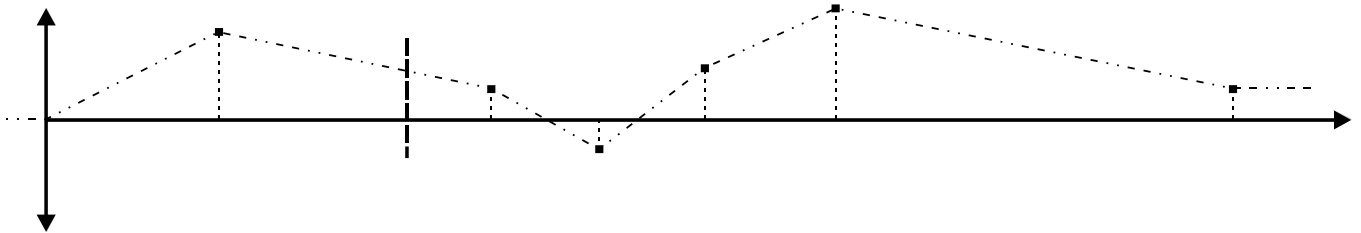

Each Correction Point is measured with respect to the Starting Point - zero - which is usually set close to one end of the scale. The Reference Point can be set anywhere along the scale, and does not need to coincide with either the absolute datum or any of the correction points.

However, it may be convenient to make the absolute datum and the reference point the same.



Always approach the Starting Point, Correction Points and Reference Point from the same direction. If not, then the size of the tool or probe will render the measurement inaccurate.

## Teach Mode

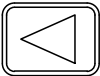

Navigate to the Error compensation selection screen **SETUP - ERR COMP**

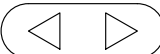
The default value for each of the axis is **none**

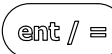
Press the axis select key  next to the 'X', 'Y' or 'Z' axis that requires segmented compensation the message display will show **CMP 1-- NONE** (CMP 1 = X axis, CMP 2 = Y axis & CMP 3 = Z axis)

  until the message display shows **CMP 1-- SEGMENTS** 

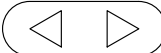
**Note:** When segmented error compensation teach is started the previous values set are deleted (Set to 0)

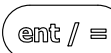
**SEG 1-- TEACH**   to choose teach rather than program 

**0000** encoder position (ref point)

**TCH 1-- SET REF** 

**0000** encoder position (zero point)

**TCH 1-- SET 0** 

# Setting up the unit

## Teach Mode Continued

2000

encoder position (position 1)

TCH 1-- GO TO 001

ent / =

TCH 1-- MOVEMENT

enter the actual measurement using the numeric keypad

ent / =

2.150

value entered in previous step

TCH 1-- MOVEMENT

ent / =

0.150

compensation value

TCH 1-- ACCEPT

ent / =

TCH 1-- CONTINUE

ent / =

continue to position 2



to exit setup and return to menu, or



to exit setup and return to measurement display

When segmented compensation is enabled it is necessary to move to a start / reference point when the unit has had its power cycled. The below message will be shown on the NMS300 display when this is required.

RESET

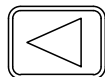

RESET-- SEGMENTS





# Setting up the unit



## Program Mode

Navigate to the Error compensation selection screen **SETUP-- ERR COMP**

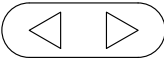
The default value for each of the axis is **none**

Press the axis select key  next to the 'X', 'Y' or 'Z' axis that requires segmented compensation the message display will show **CMP 1-- NONE** (CMP 1 = X axis, CMP 2 = Y axis & CMP 3 = Z axis)

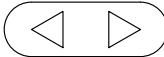
  until the message display shows **CMP 1-- SEGMENTS** 



**SEG 1-- PROGRAM**   to choose program rather than teach 

**2000** correction point position

**0.150** correction value (compensation)

**PAG 1-- SEG 001** 

**Note:** Pressing  will delete both correction point position and correction value (Set to 0)

  to move to segment 2 and the repeat the process above

 to exit setup and return to menu, or  to exit setup and return to measurement display

When segmented compensation is enabled it is necessary to move to a start / reference point when the unit has had its power cycled. The below message will be shown on the NMS300 display when this is required.

**-RESET** 

**RESET-- SEGMENTS**

## Delete Mode

The example below has the X axis chosen in the segmented error compensation menu, repeat the below process with another axis selected to delete the segmented compensation in that axis.

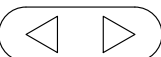
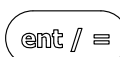
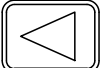
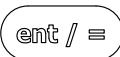
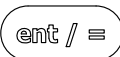
segmented compensation menu  **SEG 1-- DELETE**  **no**   
**YES**   
**SEG 1-- SURE** 

**Important note:** this will delete all the current data in the X axis

# Setting up the unit

## Plane Setup

This setting defines the machining face of the work piece, for example; on a turret mill it would typically be the X Axis and the Y Axis. This setting is used by the mill functions.

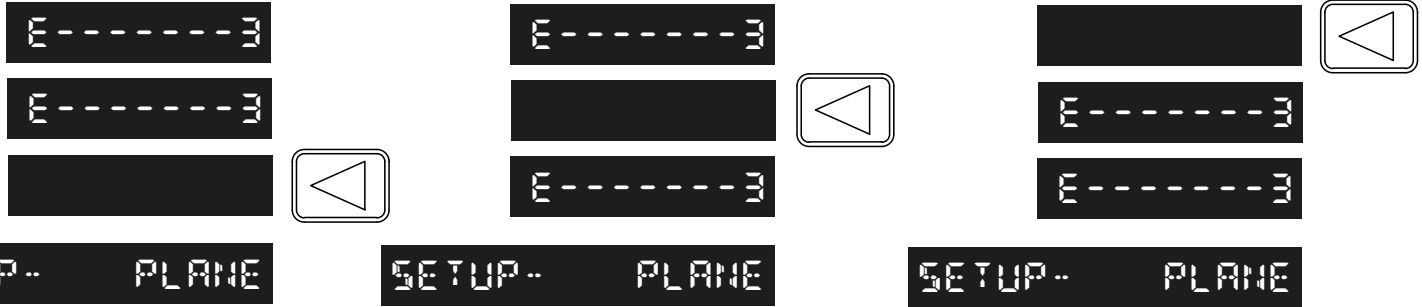

to exit setup and return to menu, or to exit setup and return to measurement display

## Functions Setup

Allows the user to enable or disable Mill / Lathe functions. Some functions may already be turned off/on due to the type setup being set to Mill or lathe.

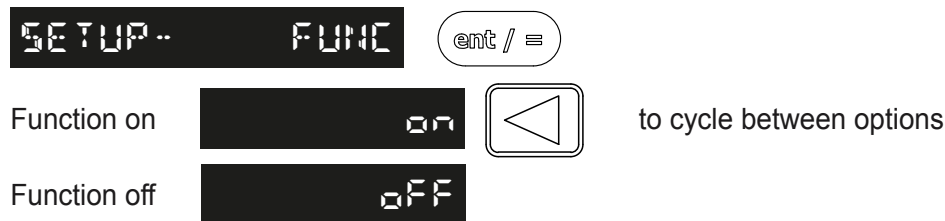

to navigate through the functions available as per the below:

- FUNC -- ARC** Arc contouring function
- FUNC -- DIGIFIND** Digifind reference function
- FUNC -- FEED** Feed rate function
- FUNC -- LINE** Line hole function
- FUNC -- PCØ** Pitch Circle Diameter / bolthole function
- FUNC -- POCKET** Pocket or island milling
- FUNC -- SDM** Sub datum memory
- FUNC -- TAPER** Taper turning
- FUNC -- TOOL** Tool offsets

# Setting up the unit

## Feed Setup

00 in/Min

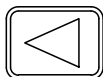

to change between minutes and seconds

SETUP-- FEED

Settings available are: in/minutes, in/second, mm/minutes & mm/second

00 seconds

SETUP-- FEED



to change from inches to millimetres in conjunction with this function

## Brightness Setup

00 id

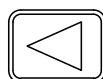

The default brightness is medium

SETUP-- BRIGHT

high



Setting to high brightness increases the display brightness to its maximum

SETUP-- BRIGHT

Low

Setting to low brightness decreases the display brightness to its minimum

SETUP-- BRIGHT

## Tone / Beep Setup

This setting enables or disables an audible tone coming from the unit when a button is pressed.

on



The default setting is on

SETUP-- BEEP

off

Once turned off no audible tone will be made

SETUP-- BEEP

# Setting up the unit

## Sleep Setup

This setting enables the user to define an automatic sleep mode after a period of time. The user either leaves the default setting at 0 which deactivates the sleep mode, or inputs a value (in whole minutes) for when the sleep mode is initiated after no operation of the NMS300.

To exit sleep mode, simply move an axis or press any key.



0 disables the sleep function



sleep function active after 15 minutes



Once the required value is entered via the numeric keypad, press  to accept the value

## Reset Setup

This setting enables the NMS300 to be reset to its default parameters.

**WARNING::** Enabling this setting will erase any data that was previously stored in the functions and settings of the readout.



Navigate to this message display in settings

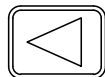

Confirm that a reset is required by pressing the axis key



to exit setup and return to menu, or



to exit setup and return to measurement display



# Standard functions

## Absolute / Incremental

Press the  key to toggle between absolute and incremental modes.

The NMS300 has a dedicated key to switch the positional displays between absolute (abs) and incremental (inc) measurements. The current display mode is indicated at the bottom of the screen as shown on the right.



Absolute (abs) mode has been selected



Incremental (inc) mode has been selected



### Using incremental mode

In Incremental mode the DRO displays the position relative to the last position. This is also known as point-to-point use. In this mode set the value for each axis, or zero it to create an Incremental datum. This does not effect the machine's Absolute datum that is configured in Absolute mode.

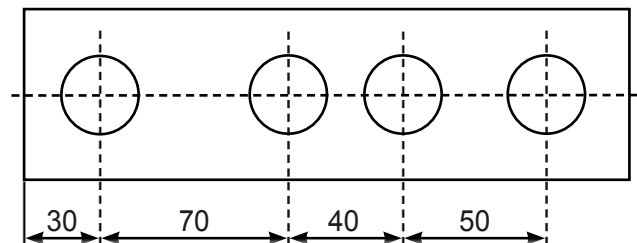

### Using absolute mode

In Absolute mode the DRO displays the positions of all the axes with respect to a fixed datum. The datum is set by entering an axis position when in Absolute mode.

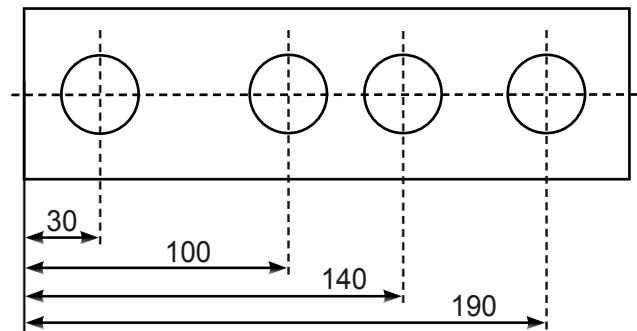

### Example of absolute and incremental use

Set absolute zero at lower left corner of the part



move to second position in ABS (hole B)

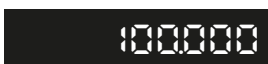
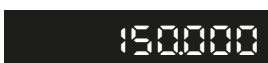

make an incremental move to hole C

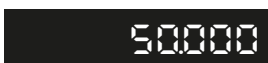

move to first position in ABS (hole A)

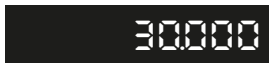
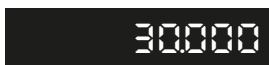

switch to incremental mode and zero the display



switch to absolute mode

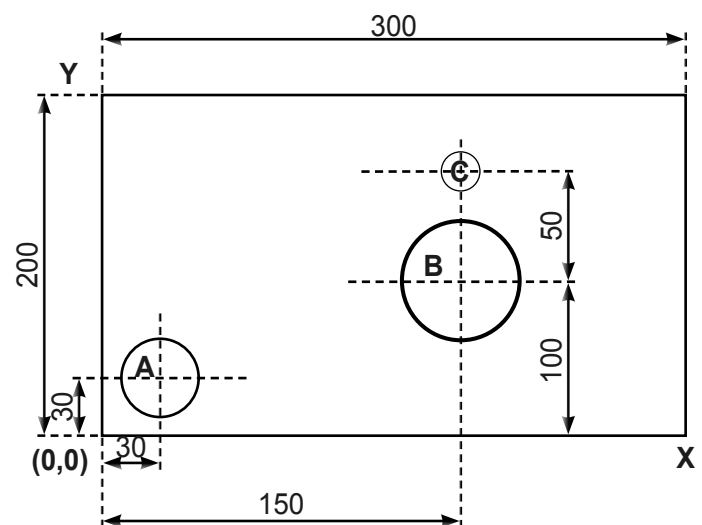
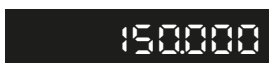
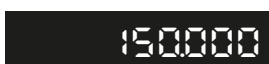

# Standard functions

## Inch and mm modes

Press  to toggle between Inch and mm measurement modes.

The NMS300 has a dedicated key to switch the positional displays between imperial (inch) and metric (mm) measurements. The current display mode is indicated at the bottom left of the screen as shown right.



Metric (mm) mode has been selected



Imperial (In) mode has been selected



## Zero and pre-set an axis

Press  to toggle between set and zero modes.

The NMS300 has a dedicated key to switch the operation of the axis selection key between zero and set modes. The currently selected mode is indicated at the bottom right of the screen as shown.



Set mode has been selected



Zero mode has been selected



## Using set mode

With the set mode selected, the select axis key prompts a numeric entry into the desired axis.

Once the correct value has been selected, it can be set into the axis by pressing the enter key. This can be seen in the example on the right.

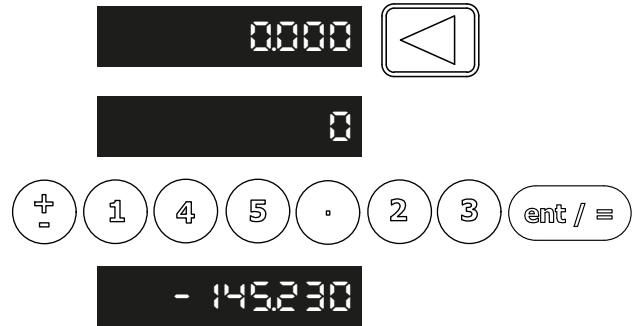

## Zeroing an axis in set mode

With set mode selected, it is possible to zero an axis conveniently by holding down the axis select key for at least 3 seconds. This allows the user to zero an axis but stay in the pre-set mode. Use of this feature can be seen in the example on the right.

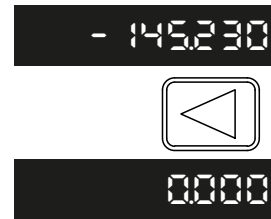

## Using zero mode

With zero mode selected, this enables the select axis keys to zero each axis independently. This can be seen in the example on the right.



# Standard functions

## Undo function

The NMS300 stores the last 10 positions / numeric inputs, which can be accessed using the undo  feature.



### Example 1 - non movement

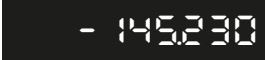

display shows  input a value 

an incorrect figure has been accepted but the dimension shown previously is required.

press  display now shows 

### Example 2 - movement

input a value  move to that point, display now shows 

input a value  move to that point, display now shows 

Press  once, display now shows  this is the position of the second point

Press  again, display now shows  this is the position of the starting point

**Important note:** the undo key is also used for returning to the previous menu structure when in the readout settings and functions.

## Half function / centre find

Press  to initiate the half function.

The NMS300 has a dedicated key to half the value in any axis. This is achieved by pressing the half key and then selecting the required axis to have the value halved. Example shown on the right.

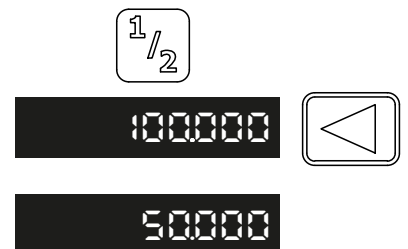

# Standard functions

The NMS300 has multiple ways of accessing functions, via the main menu & the function keys.

## Functions Menu



- MENU -- TOOL    Generic & Lathe
- MENU -- PCI    Generic & Mill
- MENU -- LINE    Generic & Mill
- MENU -- ARC    Generic & Mill
- MENU -- POCKET    Generic & Mill
- MENU -- 5DM    Generic, Mill & Lathe
- MENU -- TAPER    Generic & Lathe
- MENU -- FEED    Generic, Mill & Lathe
- MENU -- DIGIFIND    Generic, Mill & Lathe

Once the correct function has been located press to select the function (set parameters / use)

## Setting Function keys

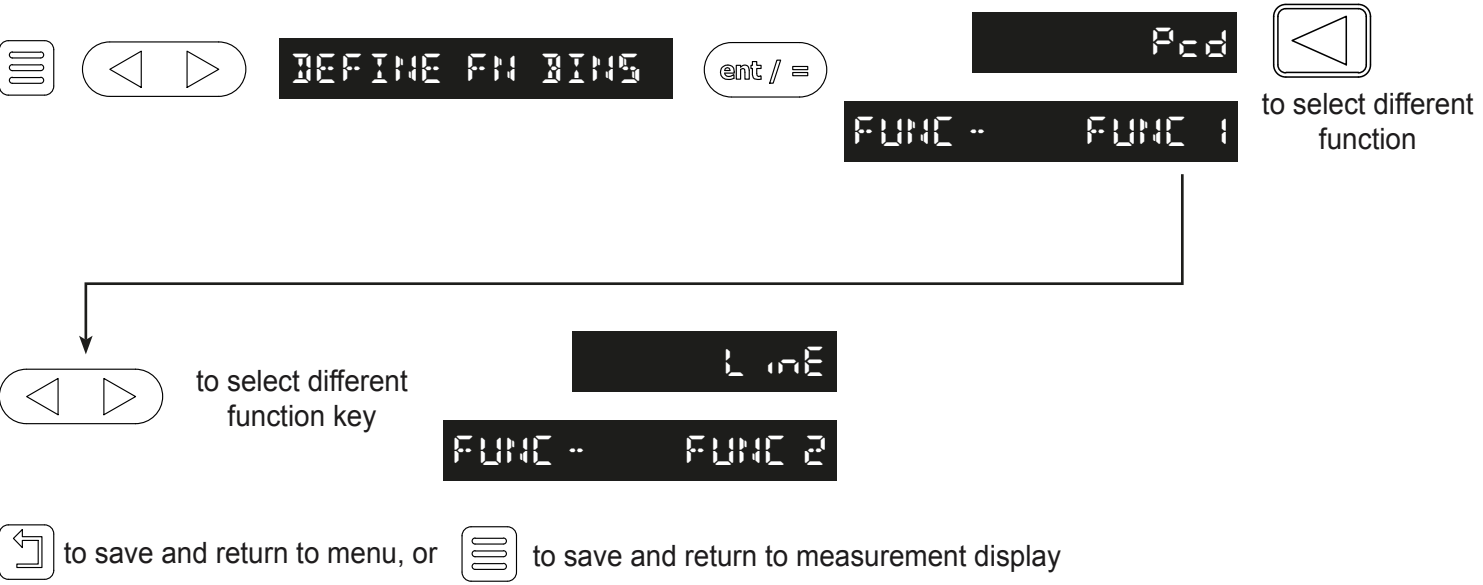



# Standard functions

## Quick Setting Function Keys

It is possible to set the function keys without having to go through the menu structure, this enables the function keys to be defined quicker if they need to be changed more often.

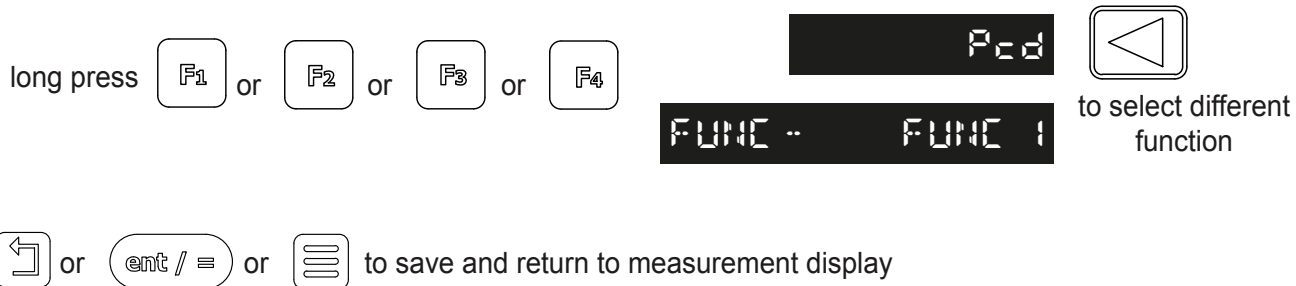

## Using Function keys

Before being able to use a function key it must be assigned to a function as per the above instructions, this may have been completed by setting the unit to a machine type in the setup.

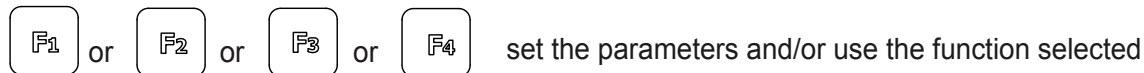

## Digifind / reference function

The NMS300 comes equipped with Digifind, a feature unique to Newall digital readout products. Digifind eliminates the risk of losing position and datum Set-Up. With Digifind, precise Set-Up of a work-piece is carried out only one time. When the NMS300 is powered on, it displays the position at power off, compensated for any movement of a Spherosyn encoder up to 0.2500" (6mm) and a Microsyn encoder up to 0.1000" (2.5mm) in either direction since the unit was last used. If the machine has moved beyond 0.2500" (6mm) - Spherosyn [0.1000" (2.5mm) - Microsyn], Digifind allows a quick means to find the datum if lost.

A mark must be made on both a stationary part and moving part of the machine. The marks must be aligned and will serve as the machine "home" position.

The mark must be indelible, and it must allow the operator to move the machine to within a 0.2500" (6 mm) - Spherosyn [0.1000" (2.5mm) - Microsyn ] band around the mark at any time. Alternatively, use a convenient reference point on the work-piece.

# Standard functions

## Digifind / reference function continued

To use digifind one of the function keys must be assigned to the digifind function - see the section function keys

### Setting the reference

Press the function key that has been assigned to digifind, (in this example the digifind has been assigned to the F4 key).

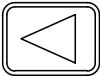

Press the axis select key  next to the 'X', 'Y' or 'Z' axis that requires the reference setting.

### Finding the reference

If the reference is lost at anytime it is possible to 'find' the reference again. Position the machine to within 6mm (0.2500") band for Spherosyn and 2.5mm (0.1000") band for Microsyn. Press the function key that has been assigned to digifind, (in this example the digifind has been assigned to the F4 key).

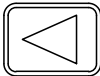

Press the axis select key  next to the 'X', 'Y' or 'Z' axis that requires the reference to be found.

### Finding zero

If the datum is lost at anytime it is possible to 'find' the datum again. Position the machine to within 6mm (0.2500") band for Spherosyn and 2.5mm (0.1000") band for Microsyn. Press the function key that has been assigned to digifind, (in this example the digifind has been assigned to the F4 key).

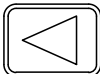

Press the axis select key  next to the 'X', 'Y' or 'Z' axis that requires the reference setting.

## Sub datums / memory

The NMS300 can store up to 200 SDM (Sub-Datum) positions, or machining steps into the memory. Using SDM allows the operator to work to zero by calling up stored dimensions, instead of "working up" to drawing dimensions. This eliminates the need to constantly refer to the drawing, and reduces the possibility of scrapping parts due to misread dimensions. It also speeds up positioning because the operator works to zero.

The SDMs are stored as co-ordinates relative to the current absolute / incremental datum position. If the absolute / incremental datum position changes, the SDMs will "shift" to the new datum.

Once a repetitive sequence of co-ordinates is entered into SDM, the co-ordinates can be recalled at any time. The positions remain in memory until altered by the operator. Simply assign any SDM number 1 - 200 to each machining step. When machining, call up each step (SDM) number and work to zero.

There are two ways to store Sub datums, Teach mode and program mode. See example on the next page:

To use sub datums one of the function keys must be assigned to the sub datum (SDM) function - see the section function keys

# Standard functions

## Teach Mode

To use sub datums one of the function keys must be assigned to the sub datum (SDM) function - see the section function keys

Press the function key that has been assigned to sub datums, (in this example the sub datum has been assigned to the F3 key).



Move the axis 'X', 'Y' and/or 'Z' to the 1st location

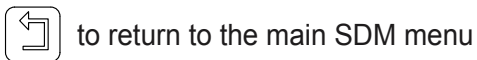
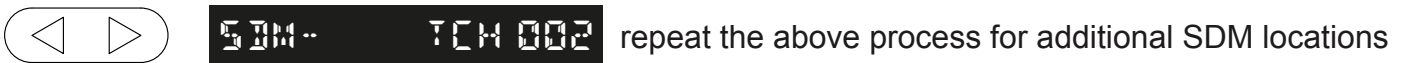

## Program Mode

Press the function key that has been assigned to sub datums, (in this example the sub datum has been assigned to the F3 key).

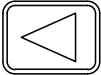
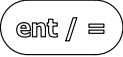

Press the axis select key  next to the 'X', 'Y' or 'Z' axis that requires the position setting, enter the dimension using the numeric keypad. 

**Note:** Pressing  will delete all offset values displayed (Set to 0)

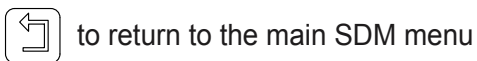
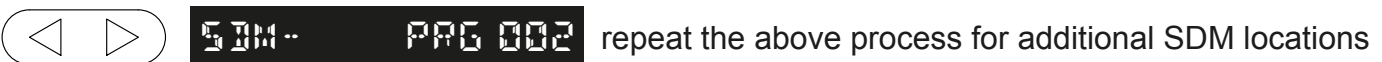

## Delete Mode

Press the function key that has been assigned to sub datums, (in this example the sub datum has been assigned to the F3 key).



**Important note:** this will delete all the current data in all SDM's

# Standard functions

## Use Mode

Press the function key that has been assigned to sub datums, (in this example the sub datum has been assigned to the F3 key).

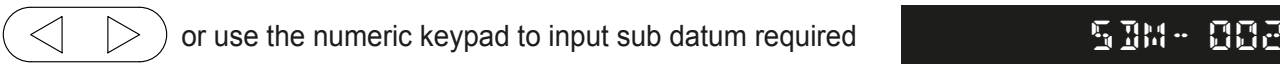

 to exit SDM use and return to SDM menu, or  to exit setup and return to measurement display

The function can also be exited by pressing the function key that has been assigned to sub datums

## Feed rate function

To use the feed rate function one of the function keys must be assigned to feed - see the section function keys

Press the function key that has been assigned to feed, (in this example feed has been assigned to the F2 key).



**Important note:** the feed rate will be shown for the fastest moving axis

# Mill functions

## PCD / bolt hole circle

To use PCD / bolt hole circle one of the function keys must be assigned to the PCD function - see the section function keys. Press the function key that has been assigned to PCD, (in this example the PCD has been assigned to the F2 key).

The NMS300 calculates positions for a series of equally spaced holes around the circumference of a circle. The message display prompts the user for various parameters it needs to do the calculations.

Once the NMS300 completes the calculations, the axis displays show the distance to each hole. The operator works to zero for each hole location. See example below.

**F2** 125.250  
99.700 Enter centre co-ordinate (see using set mode P20)

**PCD-- CENTRE** ent / =

150.000 Enter diameter value (see using set mode P20)

**PCD-- DIAMETER** ent / =

5 Enter the number of holes (see using set mode P20)

**PCD-- HOLES** ent / =

18 Enter the start angle (see using set mode P20)

**PCD-- ANGLE** ent / =

**Important note:** The PCD will be calculated from the 3 O'clock position, anti-clockwise. Enter the angle as a negative value if it is given as clockwise from the 3 O'clock position.

**PCD-- GO** ◀ ▶ At any stage the ◀ ▶ keys will move back and forth through the above menus to make any further adjustments, if the settings are OK then press ent / =

- 196.580  
- 122.880

**PCD--HOLE 1**

Navigate through the sequence of holes by using ◀ ▶

Alternatively use the numeric keypad to select the hole required.

The maximum number of holes for this function is 999

↶ to exit PCD use and return to PCD menu, or

☰ to exit PCD and return to measurement display

The function can also be exited by pressing the function key that has been assigned to PCD

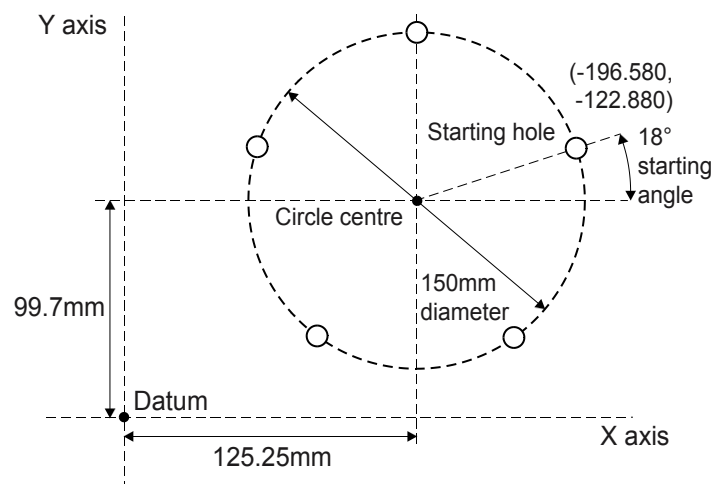



# Mill functions

## Line hole

To use line hole one of the function keys must be assigned to the line hole function - see the section function keys. Press the function key that has been assigned to line hole, (in this example the line hole has been assigned to the F3 key).

The NMS300 calculates positions for a series of equally spaced holes in a line. The message display prompts the user for various parameters it needs to do the calculations.

Once the NMS300 completes the calculations, the axis displays show the distance to each hole. The operator works to zero for each hole location. See example below.

Enter starting co-ordinate (see using set mode P20)

LINE -- START 



Enter total length of line (see using set mode P20)

LINE -- LENGTH 



Enter the number of holes (see using set mode P20)



LINE -- HOLES 



Enter the start angle (see using set mode P20)

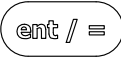

LINE -- ANGLE 

LINE -- GO

At any stage the   keys will move back and forth through the above menus to make any further adjustments, if the settings are OK then press 

  



LINE -- HOLE 1

Navigate through the sequence of holes by using  

Alternatively use the numeric keypad to select the hole required.

The maximum number of holes for this function is 999

 to exit line hole use and return to line hole menu, or

 to exit line hole and return to measurement display

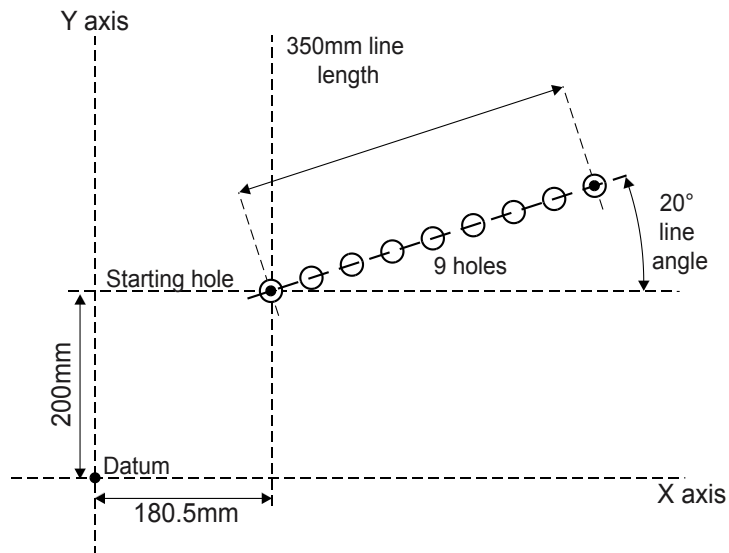

The function can also be exited by pressing the function key that has been assigned to line hole

# Mill functions

## Arc contouring

To use arc contouring one of the function keys must be assigned to the arc contouring function - see the section function keys. Press the function key that has been assigned to arc contouring, (in this example arc contouring has been assigned to the F4 key).

The NMS300 calculates positions for a series of equally spaced holes in an arc. The message display prompts the user for various parameters it needs to do the calculations.

Once the NMS300 completes the calculations, the axis displays show the distance to each hole. The operator works to zero for each hole location. See example below.

<b>F4</b>	<b>ARC -- CENTRE</b>	Enter centre co-ordinate (see using set mode P20)	<b>3.35000</b>	<b>ent / =</b>
	<b>ARC -- START</b>	Enter start co-ordinate (see using set mode P20)	<b>2.35000</b>	<b>ent / =</b>
	<b>ARC -- END</b>	Enter end co-ordinate (see using set mode P20)	<b>4.82600</b>	<b>ent / =</b>
	<b>ARC -- RADIUS</b>	Enter the radius of the arc (see using set mode P20)	<b>5.35000</b>	<b>ent / =</b>
	<b>ARC -- TOOL DIA</b>	Enter the tool diameter being used (see using set mode P20)	<b>4.17400</b>	<b>ent / =</b>
	<b>ARC -- MAX CUT</b>	Enter the maximum cut required (see using set mode P20)	<b>2.70000</b>	<b>ent / =</b>
	<b>ARC -- CUT TYPE</b>	Enter the cut type required (see using set mode P20)	<b>0.50000</b>	<b>ent / =</b>
	<b>ARC --</b>		<b>0.15000</b>	<b>ent / =</b>

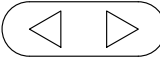
**ARC -- GO** At any stage the  keys will move back and forth through the above menus to make any further adjustments, if the settings are OK then press **ent / =**

**-2.3520**

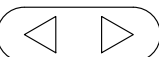

**-4.5974**

**ARC -- HOLE 001**

Navigate through the sequence of holes by using 

Alternatively use the numeric keypad to select the hole required.

The maximum number of holes for this function is 999

-  to exit line hole use and return to line hole menu, or
-  to exit line hole and return to measurement display

The function can also be exited by pressing the function key that has been assigned to line hole

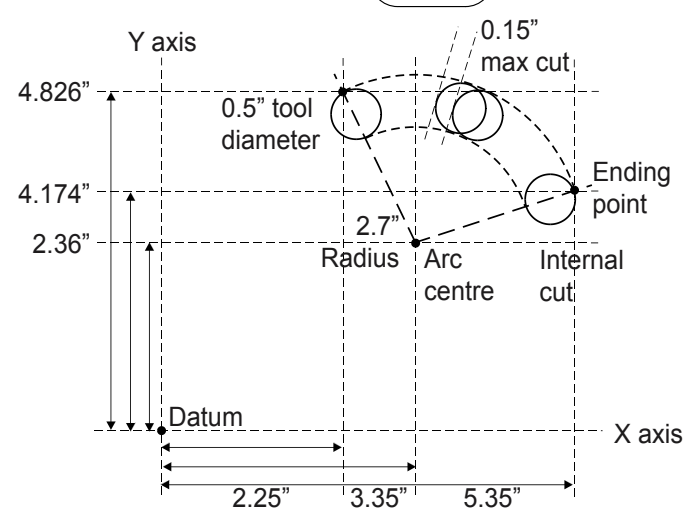

# Mill functions

## Pocket / Island Milling

To use pocket milling one of the function keys must be assigned to the pocket milling function - see the section function keys. Press the function key that has been assigned to pocket milling, (in this example pocket milling has been assigned to the F1 key).

The NMS300 calculates positions for each corner of pocket / island required. The message display prompts the user for various parameters it needs to complete the calculations.

Once the NMS300 completes the calculations, the axis displays show the distance of each corner from the datum. The operator works to zero to complete a circumference cut of the pocket / island. See example below.

<div style="border: 1px solid black; padding: 2px; display: inline-block;">F1</div>	350.000	
	400.000	Enter centre co-ordinate (see using set mode P20)
	PCKT-- CENTRE	(ent / =)
	200.000	Enter height of the pocket / island required (see using set mode P20)
	PCKT-- HEIGHT	(ent / =)
	200.000	Enter width of the pocket / island required (see using set mode P20)
	PCKT-- WIDTH	(ent / =)
	8.000	Enter the tool diameter being used (see using set mode P20)
	PCKT-- TOOL DIA	(ent / =)
	12	Enter the cut type (see using set mode P20)
	PCKT-- CUT TYPE	(ent / =)
	PCKT-- GO	At any stage the <span style="border: 1px solid black; border-radius: 50%; padding: 2px;">◀ ▶</span> keys will move back and forth through the above menus to make any further adjustments, if the settings are OK then press <span style="border: 1px solid black; border-radius: 50%; padding: 2px;">(ent / =)</span>
	-254.000	
	-304.000	
	PCKT-- POINT 1	Navigate through the sequence of corners by using <span style="border: 1px solid black; border-radius: 50%; padding: 2px;">◀ ▶</span>

Alternatively use the numeric keypad to select the corner required. The number of pocket points will always be 4 it is expected the user will reach point 4 and move on to point 1 to complete the pattern

- ↶ to exit line hole use and return to line hole menu, or
- ☰ to exit line hole and return to measurement display

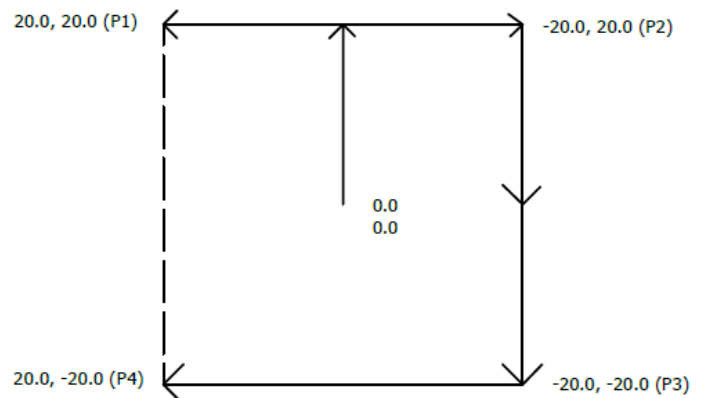

The function can also be exited by pressing the function key that has been assigned to line hole



# Lathe functions

## Tool Offsets

To use tool offsets one of the function keys must be assigned to the tool offset function - see the section function keys  
Press the function key that has been assigned to tool offsets, (in this example tool offsets has been assigned to the F1 key).

The NMS300 can store up to 50 tool offsets, this large number allows tools to be grouped where more than one set is used. For convenience, it is highly recommended that tools are physically marked with their corresponding tool number. There are multiple ways to set tool offsets, teach mode, program mode and quick edit mode.

**Note:** Once tools are enabled they stay enabled even when other functions are used

## Teach Mode



take a skim cut with X and/or a face cut with Z  to capture all axes 

**Note:** to capture a single axis press the axis select key instead of the enter key

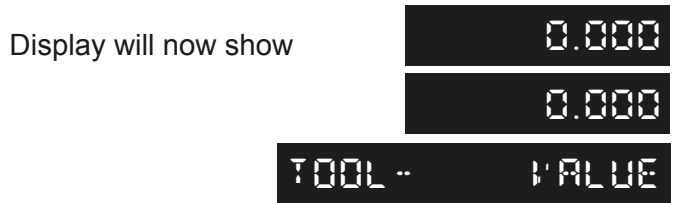

Note: at this point the tool can be moved away from the part

Measure the part with an accurate gauge and enter this value into the relevant axis (see using set mode P20)

Repeat the process above for all other tools required



## Program Mode

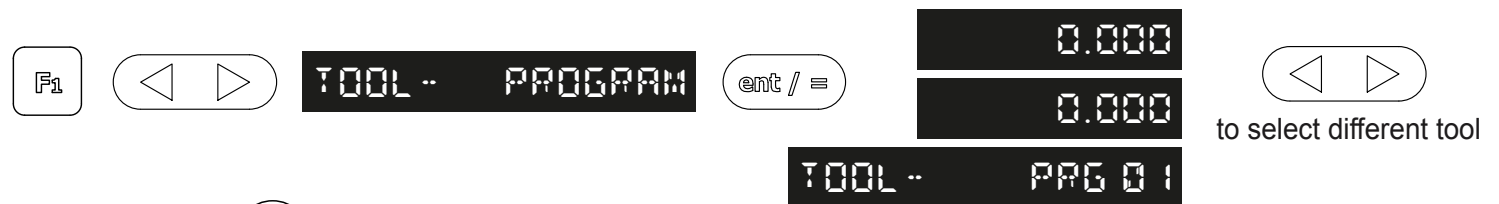

**Note:** Pressing  will delete all offset values displayed (Set to 0)

take a skim cut with X and/or a face cut with Z

**Note:** at this point the tool can not be moved away from the part

Measure the part with an accurate gauge and enter the difference between the measured diameter and the readout value into the relevant axis (see using set mode P20)

Repeat the process above for all other tools required

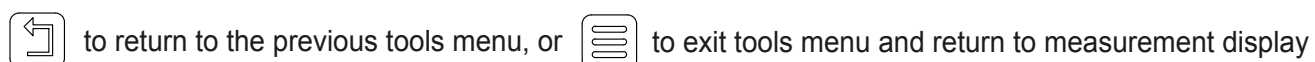

# Lathe functions

## Use Mode

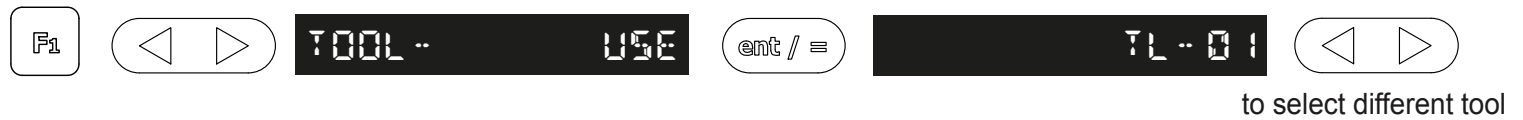

**Note:** Different tools can be selected by entering the tool number required using the numeric keypad

## Quick Edit Mode

While in the using tool offsets mode tools can be edited / created quickly, without having to go back through the tool program or teach modes. The procedure to do this is demonstrated below:

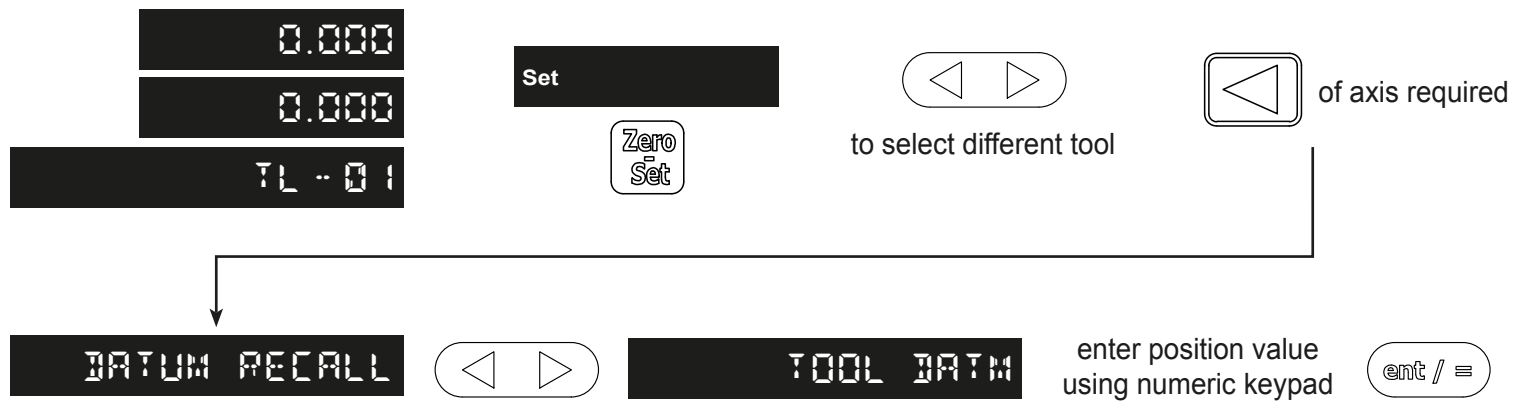

Repeat the above process for other axes or tools

## Delete Mode

This function is designed to delete **ALL** the tool offsets, if one tool is to be changed quick tool edit should be used.



# Lathe functions

## Taper Turning

To use taper one of the function keys must be assigned to the taper function - see the section function keys  
Press the function key that has been assigned to taper, (in this example taper has been assigned to the F2 key).

The taper function shows the angular displacement of the displayed (X,Z) position.

F2

touch tool to one end of the taper and zero both axes, then touch the tool on the other end of the taper.

10.000  
50.000  
TAPER 11.30993

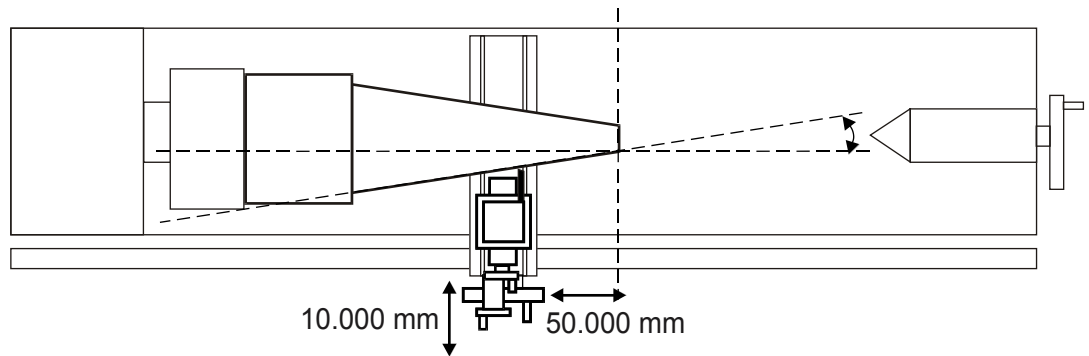

# Trouble shooting guide

Symptom	Solution
The display is blank	<ul style="list-style-type: none"> <li>• The NMS300 maybe in sleep mode. Press any key to exit sleep mode</li> <li>• Check that the power supply is correctly connected to a working mains outlet</li> <li>• Check that the power supply cables are not damaged</li> <li>• Check that the power supply voltage is 15 - 24Vdc <math>\pm</math>10%</li> </ul>
The display works, but resets from time to time without any keys being pressed.	<p>Either the supply voltage is too low, or the power supply or mains supply has an intermittent fault.</p> <ul style="list-style-type: none"> <li>• Check that the power supply voltage is 15 - 24Vdc <math>\pm</math>10%.</li> <li>• Check that all the connections are secure.</li> </ul>
The display works, but gives erratic readings, the last digit jitters or the measurements jump to new figures unexpectedly.	<p>There may be a poor earth (ground) connection. Both the NMS300, and the machine on which it is installed, must have proper earth (ground) connections.</p> <p>There may be a problem with the encoder.</p>
The unit does not respond to any key presses.	Disconnect the NMS300 from its power supply, wait 15 seconds and then reconnect.
'NO Sig' / 'SIG FAIL' or '1.x' appears in the display.	<p>This indicates that the unit is not receiving a proper signal from the encoder.</p> <ul style="list-style-type: none"> <li>• Check that the encoder connections are secure.</li> <li>• Check that there is no damage to the connectors or to the encoder.</li> <li>• Switch the NMS300 off and back on again.</li> <li>• Swap the encoder to another axis to confirm whether the encoder or the NMS300 is at fault.</li> </ul>
Readings are incorrect.	<ul style="list-style-type: none"> <li>• Check the Encoder Type to ensure it is correct.</li> <li>• Check the Radius / Diameter setting. The Diameter setting causes the axis to read double.</li> <li>• Check the Error Compensation factors.</li> <li>• If using the Segmented Error Compensation, verify the datum position.</li> <li>• Swap the encoder to another axis to confirm whether the encoder or the NMS300 is at fault.</li> <li>• Check that there is no damage to the encoder or its cable.</li> <li>• Check that the encoder is fixed firmly and aligned correctly, as described in the Spherosyn / Microsyn Installation manual.</li> <li>• Check that there is no binding on the scale. With the scale brackets slightly loosened, you should be able to slide the scale back and forth with minimal resistance.</li> <li>• If a Spherosyn300 scale is in use, check that the scale is not bent, by removing it and rolling it on a flat surface.</li> </ul>
2.1 appears in the display	<ul style="list-style-type: none"> <li>• This indicates that the encoder has travelled further than the maximum allowed travel</li> </ul> <p>This type of error can only be cleared by cycling the power to the NMS300.</p>

**If the solutions suggested above do not solve the problem, contact Newall for further instruction.**

## To swap encoders to trace a fault:

1. Check that the two axes are set to the correct encoder types.
2. Disconnect the NMS300 power supply.
3. Disconnect the encoder from the malfunctioning axis and move to a working axis.
4. Reconnect the NMS300 power supply and turn on.

**If the fault stays with the same encoder, then the encoder is at fault. If the fault does not follow with the encoder the NMS300 is at fault.**

Providing the machine has not been moved more than 6.3mm (0.25") for a Spherosyn300 encoder or 2.5mm (0.1") for a Microsyn300 encoder, switching the power off and back on again does not lose the datum position.

Datasheets provided by Sensata Technologies, Inc., its subsidiaries and/or affiliates (“Sensata”) are solely intended to assist third parties (“Buyers”) who are developing systems that incorporate Sensata products (also referred to herein as “components”). Buyer understands and agrees that Buyer remains responsible for using its independent analysis, valuation, and judgment in designing Buyer’s systems and products. Sensata datasheets have been created using standard laboratory conditions and engineering practices. Sensata has not conducted any testing other than that specifically described in the published documentation for a particular datasheet. Sensata may make corrections, enhancements, improvements, and other changes to its datasheets or components without notice.

Buyers are authorized to use Sensata datasheets with the Sensata component(s) identified in each particular datasheet. HOWEVER, NO OTHER LICENSE, EXPRESS OR IMPLIED, BY ESTOPPEL OR OTHERWISE TO ANY OTHER SENSATA INTELLECTUAL PROPERTY RIGHT, AND NO LICENSE TO ANY THIRD PARTY TECHNOLOGY OR INTELLECTUAL PROPERTY RIGHT, IS GRANTED HEREIN. SENSATA DATASHEETS ARE PROVIDED “AS IS”. SENSATA MAKES NO WARRANTIES OR REPRESENTATIONS WITH REGARD TO THE DATASHEETS OR USE OF THE DATASHEETS, EXPRESS, IMPLIED, OR STATUTORY, INCLUDING ACCURACY OR COMPLETENESS. SENSATA DISCLAIMS ANY WARRANTY OF TITLE AND ANY IMPLIED WARRANTIES OF MERCHANTABILITY, FITNESS FOR A PARTICULAR PURPOSE, QUIET ENJOYMENT, QUIET POSSESSION, AND NON-INFRINGEMENT OF ANY THIRD PARTY INTELLECTUAL PROPERTY RIGHTS WITH REGARD TO SENSATA DATASHEETS OR USE THEREOF.

All products are sold subject to Sensata’s terms and conditions of sale supplied at [www.sensata.com](http://www.sensata.com). SENSATA ASSUMES NO LIABILITY FOR APPLICATIONS ASSISTANCE OR THE DESIGN OF BUYERS’ PRODUCTS. BUYER ACKNOWLEDGES AND AGREES THAT IT IS SOLELY RESPONSIBLE FOR COMPLIANCE WITH ALL LEGAL, REGULATORY, AND SAFETY-RELATED REQUIREMENTS CONCERNING ITS PRODUCTS, AND ANY USE OF SENSATA COMPONENTS IN ITS APPLICATIONS, NOTWITHSTANDING ANY APPLICATIONS-RELATED INFORMATION OR SUPPORT THAT MAY BE PROVIDED BY SENSATA.

Mailing Address: Sensata Technologies, Inc., 529 Pleasant Street, Attleboro, MA 02703, USA

## CONTACT US

Americas  
Newall Electronics Inc.  
1803 OBrien Rd  
Columbus, OH 43228  
Tel: +1 614 771 0213  
[sales@newall.com](mailto:sales@newall.com)  
[newall.com](http://newall.com)

Rest of World:  
Newall Measurement Systems, Ltd.  
Business Park, Unit 1 Wharf Way  
Glen Parva, Leicester LE2 9UT  
United Kingdom  
Tel: +44 (0) 116 264 2730  
[sales@newall.co.uk](mailto:sales@newall.co.uk)  
[newall.co.uk](http://newall.co.uk)