

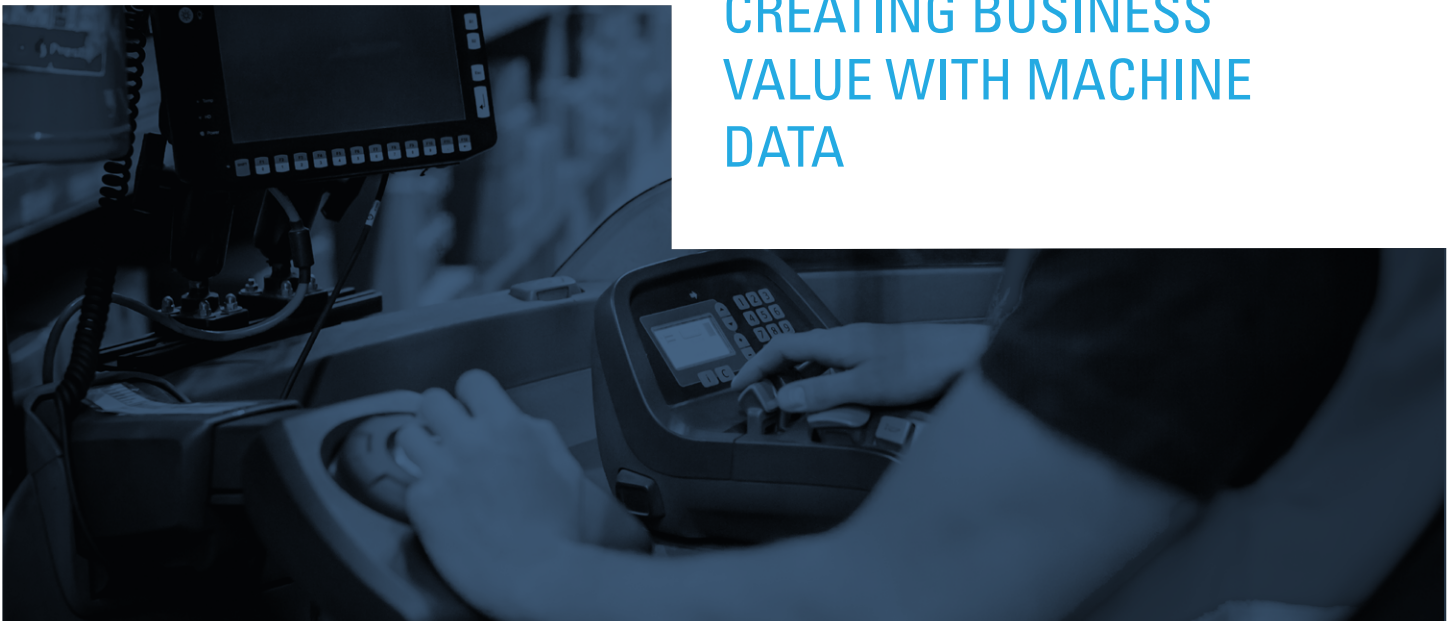

# SENSATA'S MATERIAL HANDLING TELEMATICS AND SAFETY SOLUTIONS



CREATING BUSINESS  
VALUE WITH MACHINE  
DATA

# SENSATA MATERIAL HANDLING TELEMATICS AND SAFETY PRODUCTS DELIVER NEEDS OF THE MARKET

## PLATFORM DESIGNED ON OPEN, FLEXIBLE ARCHITECTURE

Telematics and safety components are critical pieces in the research and development of the next generation of material handling equipment.

Sensata's connected systems deliver what OEMs and Rental companies need to meet their telematics needs.

We offer a range of options to deliver OEMs and rental companies what they need from basic fleet management and access control up to predictive maintenance, integrated incident recording cameras, and blind spot detection equipment.



- Modular platform to enable sensors, hardware, and data options
- Extensive and flexible designs with branded or white label offerings
- Deploy on top of existing tools
- Open ecosystem with direct connections, APIs integrations or full stack solution options
- Ability to provide a single data source from multiple disparate data sources, equipment types and brands
- Developed alongside full suite of joysticks, controls, lift control systems, and motor controllers to streamline R&D processes

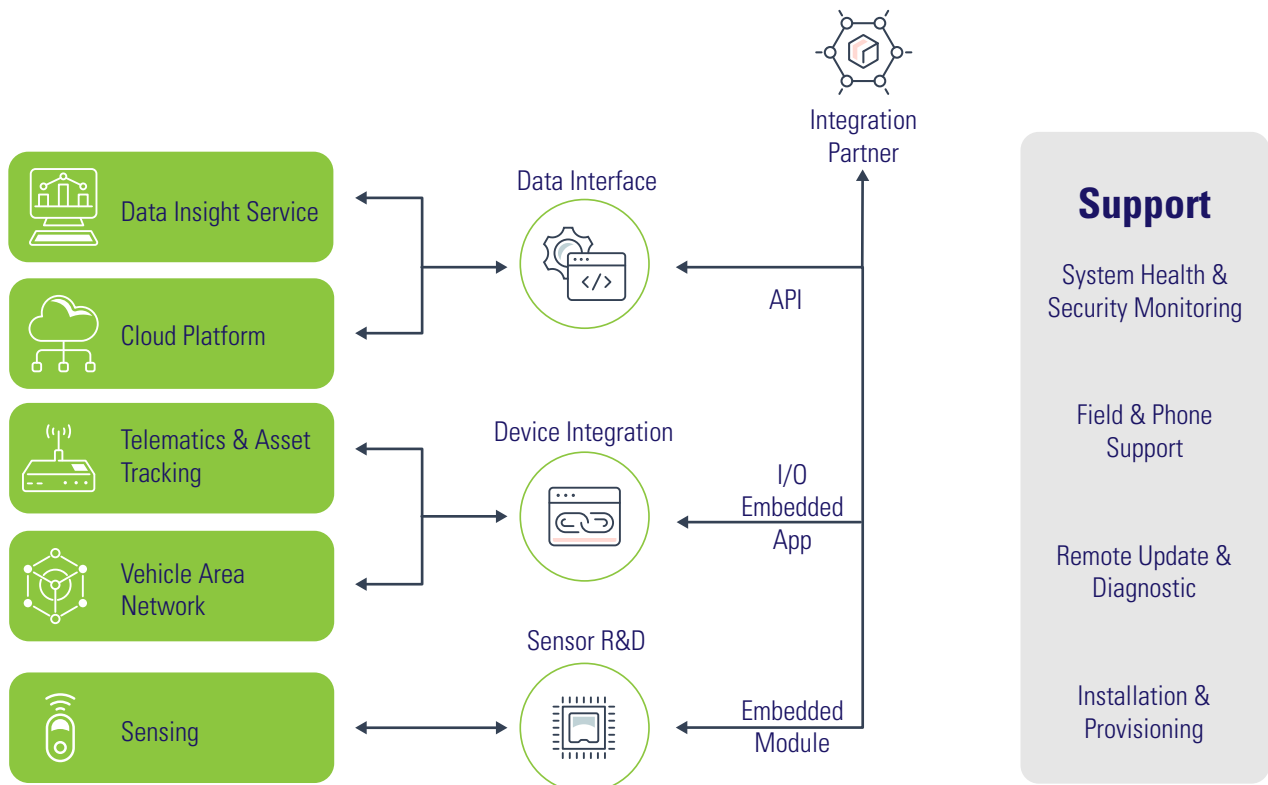

## ACCESS CONTROL AND OPERATOR VALIDATION

Reduce liability by ensuring equipment is only used by licensed and trained operators

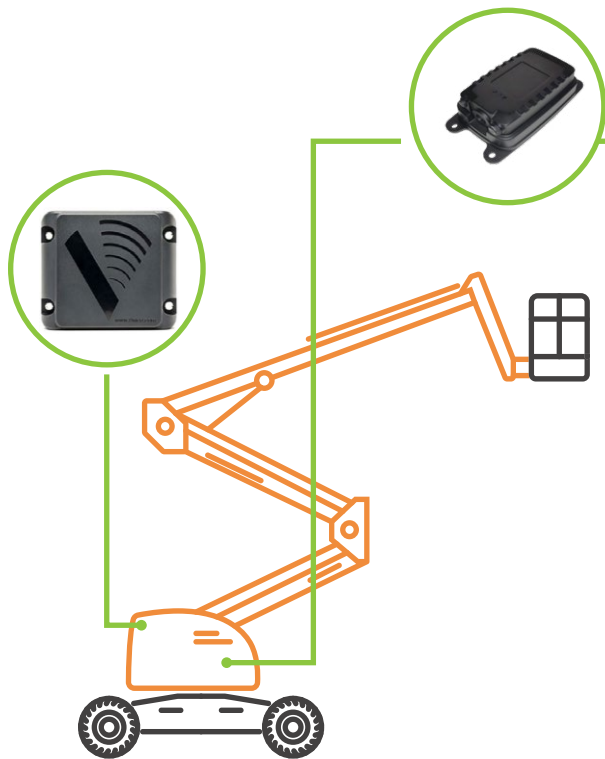

## OSHA CHECKLIST

Improve compliance processes by requiring checklist review prior to every startup

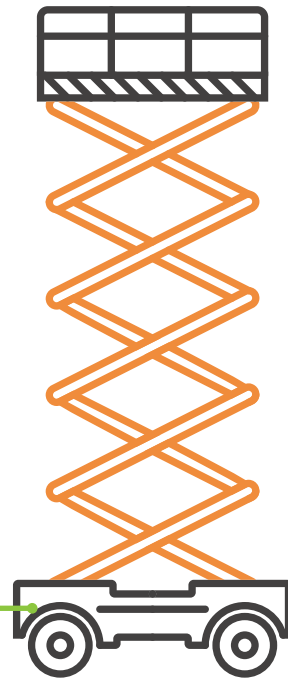

## LOCATION TRACKING AND GEOFENCING

Precise GPS monitoring to confirm equipment location and keep vehicles in safe areas

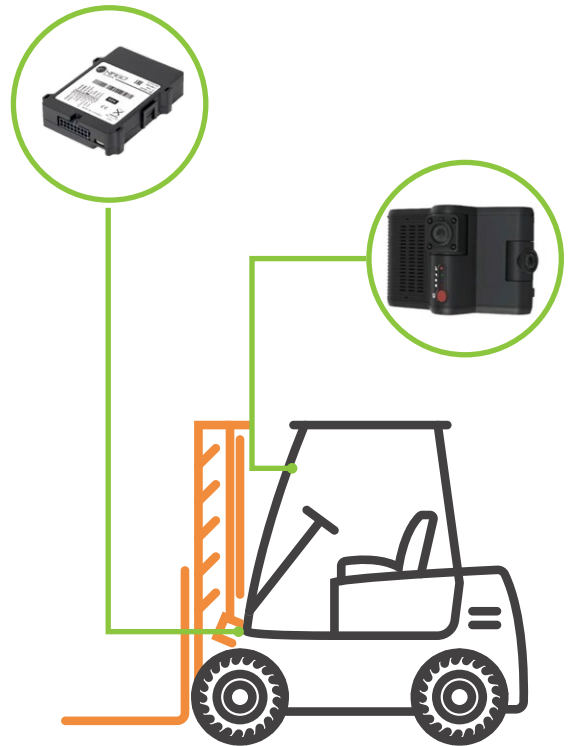

## BLIND SPOT DETECTION

Reduce incidents by monitoring vehicle blind spot zones and alerting operators to potential obstructions

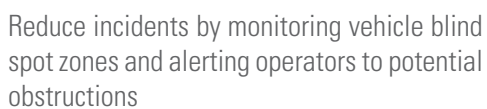

## EQUIPMENT DATA REPORTING TO UNLOCK PREDICTIVE MAINTENANCE

Monitor true odometer, usage, fuel level, engine oil life remaining, tire pressure and more from anywhere

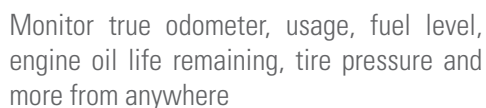

## DRIVER ACCOUNTABILITY

Impact detection technology and vehicle BUS reporting to show harsh acceleration, speeding, or fast braking. Easy-install modular camera systems to record incidents.

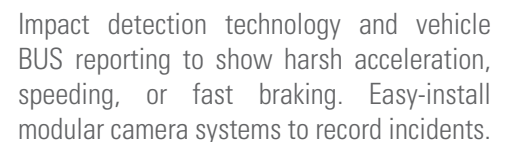

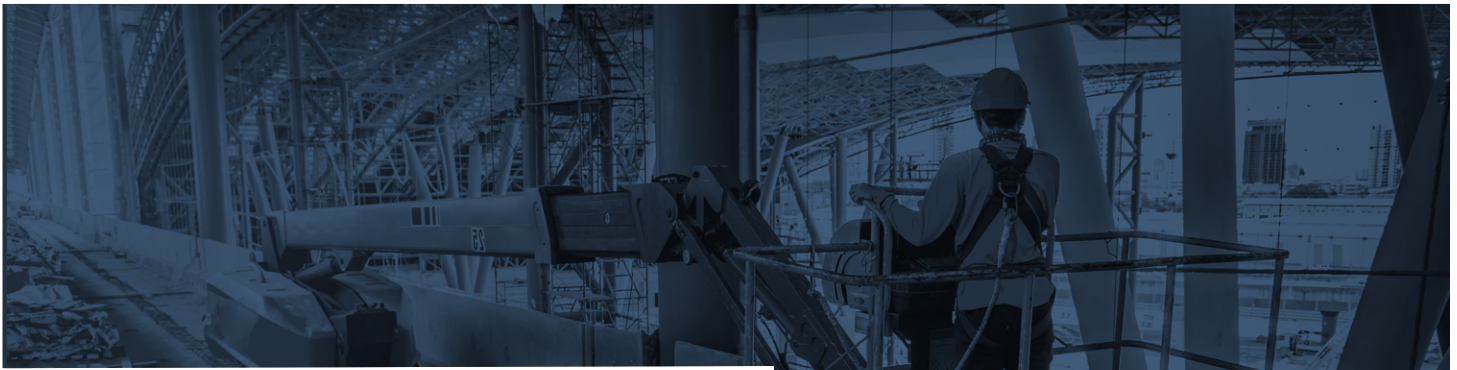

## ABOUT US

Sensata Technologies is one of the world's leading suppliers of sensing, electrical protection, control and power management solutions with operations and business centers in twelve countries. Sensata's products improve safety, efficiency and comfort for millions of people every day in automotive, appliance, aircraft, industrial, military, heavy vehicle, heating, air-conditioning and ventilation, data, telecommunications, recreational vehicles and marine applications. For more information, please visit the Sensata website.

Copyright © 2022 Sensata Technologies, Inc.  
09/01/2022

## CONTACT US

**Regional head offices:**  
**United States of America**  
Sensata Technologies  
Attleboro, MA  
Phone: 508-236-3800

**Netherlands**  
Sensata Technologies Holland B.V.  
Hengelo  
Phone: +31 74 357 8000

**China**  
Sensata Technologies China Co., Ltd.  
Shanghai  
Phone: +8621 2306 1500

---

[sensata.com](https://www.sensata.com)

---

